

A DALLAS COWBOY LOOKS AT FOOTBALL VIDEOGAMES

# VIDEOGAMING

ION INTERNATIONAL INC.

ILLUSTRATED

49140  
\$2.75



OCT.

**MEET THE ORIGINAL  
DONKEY KONG**

**READ ABOUT:**

The World's Most  
Difficult Maze Game

The Arcade Sensation  
You'll Never Play at Home

Bacteria that  
Build Computers

**ISAAC ASIMOV:**

VIDEOGAMES ARE  
GOOD FOR US

**HOW TO PUT  
MORE ZING  
IN YOUR  
FIRE BUTTON!**

**CONQUERING  
THE TOP  
VIDEOGAMES**

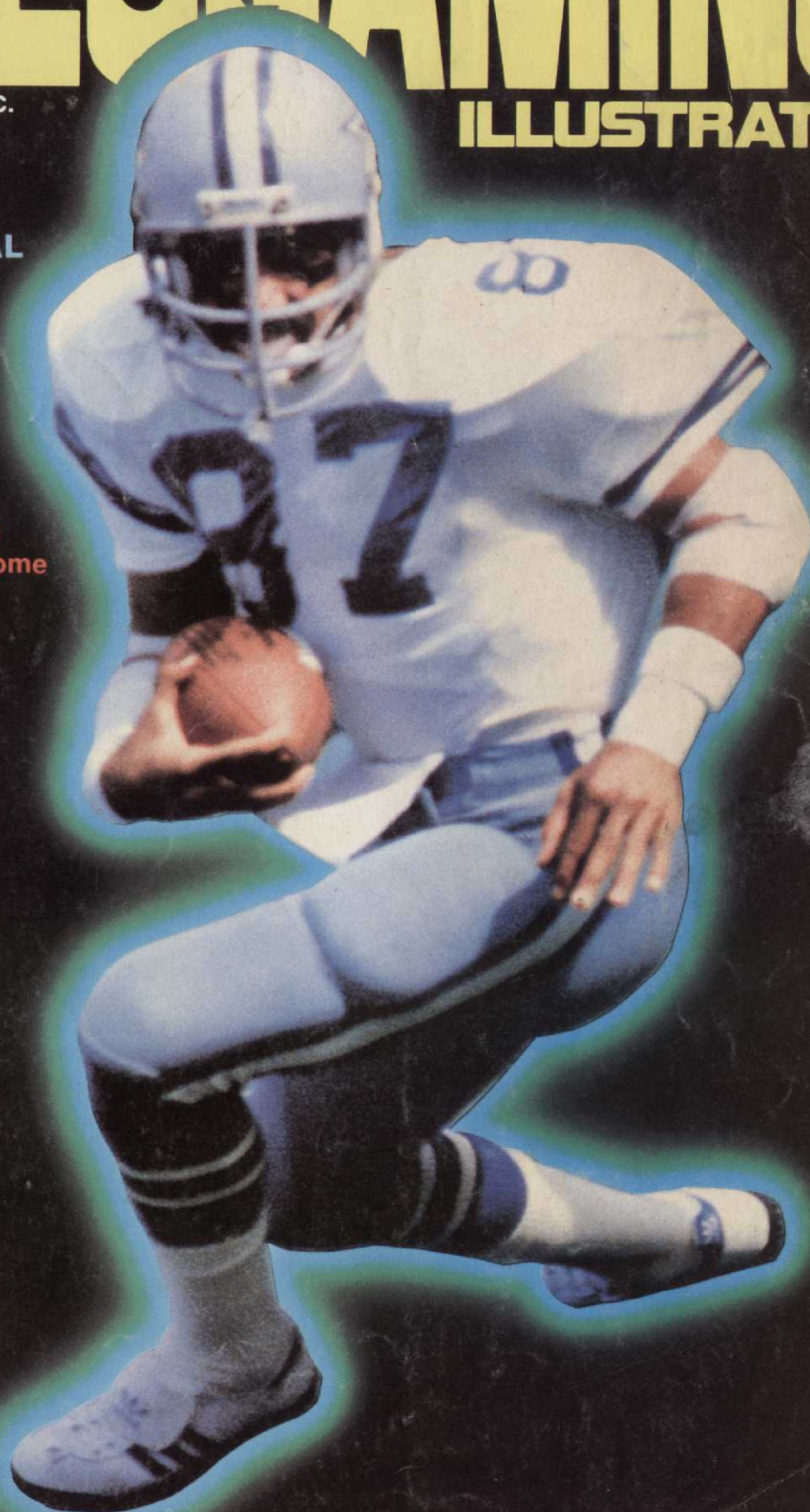



Ever since two enterprising young men turned the City Morgue into a swinging business, people have been dying to get in.

# NIGHT SHIFT



A BRIAN GRAZER PRODUCTION  
A RON HOWARD FILM "NIGHT SHIFT"  
HENRY WINKLER • MICHAEL KEATON • SHELLEY LONG  
Executive Producer DON KRANZE Written by LOWELL GANZ and BABALOO MANDEL  
Original Music by BURT BACHARACH Original Lyrics by CAROLE BAYER SAGER  
Produced by BRIAN GRAZER Directed by RON HOWARD

A LADD COMPANY RELEASE  
WARNER BROS.  
A WARNER COMMUNICATIONS COMPANY

Soundtrack Available on  
WARNER BROS. RECORDS  
and TAPES

Original Songs Performed by  
QUARTERFLASH, AL JARREAU  
and ROD STEWART

**R** RESTRICTED  
UNDER 17 REQUIRES ACCOMPANYING  
PARENT OR ADULT GUARDIAN

NOW PLAYING AT A THEATRE NEAR YOU!



# COLECO DELIVERS EXCLUSIVE, LICENSED ARCADE CARTRIDGES FOR THE ATARI® VCS™, INTELLIVISION™ AND COLECOVISION™ SYSTEMS.



CURRENTLY RATED #1 IN  
ARCADES FROM COAST TO COAST.

NOW RATED #4 IN ARCADE  
POLLS.

BASED ON THE HIGHEST RATED  
CHILDREN'S TV SHOW.

ON THE TOP SELLING CHARTS  
FOR MONTHS!

LONG-TERM ARCADE FAVORITE.

#2 RATED WOMEN'S ARCADE  
GAME.

3-D REALISM YOU MUST SEE TO  
BELIEVE!

CLIMBING TO THE TOP OF THE  
CHARTS.

COLECO DELIVERS COLECO DELIVERS COLECO DELIVERS COLECO DELIVERS

**COLECO**

ATARI® and VCS™ are trademarks of Atari, Inc. INTELLIVISION™ is a trademark of Mattel, Inc. SMURF™ is the trademark of Peyo. TURBO™, ZAXXON™, CARNIVAL™ are the trademarks of Sega Enterprises. VENTURE™ and MOUSETRAP™ are the trademarks of Exidy Incorporated. DONKEY KONG™ is the trademark of Nintendo of America Inc. LADY BUG™ is the trademark of Universal Co., Ltd.



THE WORLD WE KNOW HAS SPAWNED ANOTHER WORLD.  
A PARALLEL WORLD OF ENERGY AND LIGHT,  
A WORLD WHERE VIDEO GAME BATTLES ARE REAL.

# TRON

© MCMLXXXII Walt Disney Productions

ENTER THE WORLD OF TRON, THE VIDEO GAME FROM  
BALLY/MIDWAY, BASED ON THE FUTURISTIC ADVENTURE  
MOTION PICTURE FROM WALT DISNEY PRODUCTIONS.



*Bally* | **MIDWAY**



# VIDEOGAMING

## ILLUSTRATED

October 1982

Publisher and Editor-in-Chief	<b>Jeff Rovin</b>	Computer Editor	<b>Martin Levitan</b>
Art Director	<b>John J. Pittari</b>	Arcade Editor	<b>Richard Meyers</b>
Production	<b>CSA Inc.</b>	Consulting Editors	<b>Randy Palmer</b>
Technical Editor	<b>Jim Clark</b>		<b>Leslie Rovin</b>
Electronics Editor	<b>Lawrence Levine</b>		<b>Michael Alexanders</b>
			<b>Samuel Lawrence</b>
			<b>Steven Vincent</b>
			<b>Richard Stevens</b>

### Contents

<i>The Keyboard</i>	6
<i>Eye On</i>	7
<i>Close Up: Videogames, the Inside Story</i>	11
<i>V.I.P.: Dallas Cowboy Jay Saldi</i>	14
<i>Supergaming, Part Two</i>	19
<i>Focus On: Isaac Asimov's "The New Learning"</i>	16
<i>The Further Adventures of Tron</i>	21
<i>Conquering: Space Cavern</i>	25
<i>Conquering: Pick Axe Pete</i>	27
<i>Conquering: Space Battle</i>	29
<i>Arcadia: An Industry Tilts</i>	31
<i>Conquering: Donkey Kong</i>	40
<i>Conquering: Turbo</i>	44
<i>Star Words</i>	46
<i>Computereyes</i>	48
<i>Meet the Original Donkey Kong</i>	51
<i>Facetiae</i>	62
<i>Print Out</i>	64
<i>You Read It Here First</i>	66

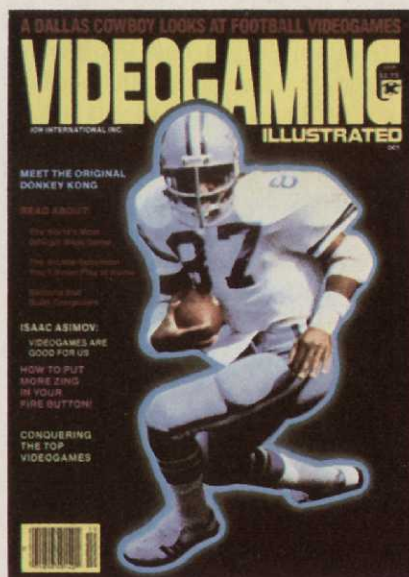

**THE COVER**  
Dallas Cowboys tight end Jay Saldi executes a yard-gaining maneuver. A professional football player for seven years, the New York born Saldi has an equally exciting off-season career, running a nascent chain of arcades. See page 14 for story.

Videogaming Illustrated is published bi-monthly, in February, April, June, August, October and December by Ion International Inc., 32 Oak Ridge Road, Bethel, CT 06801. Subscription rate: 6 issues for \$15.00 and 12 issues for \$28.00. Canada & elsewhere \$19.00 and \$36.00 respectively. Second class postage paid at Bethel, CT and at additional mailing offices. © 1982 by Ion International Inc. All rights reserved. © under Universal, International and Pan American Copyright conventions. Reproduction of editorial or pictorial content in any manner is prohibited. No responsibility can be accepted for unsolicited material. All editorial & subscription inquiries should be addressed to 32 Oak Ridge Rd., Bethel, CT 06801. Phone (203) 743-6189.



# The Keyboard



## A guest editorial

I travel across the nation quite a bit, and on my last few trips I noticed a disturbing phenomenon. In city after city, large and small, local citizens are protesting the establishment of videogame parlors in their communities. They complain that their children spend too much time in videogame arcades, spend too much money there, and that the arcades are centers for drinking, drug abuse, devil-worship ...

I've heard it all before. Back when I was a youngster (long before the development of the transistor) the parents of my generation were making the same kind of protests, in the same kind of language. They were protesting against pool parlors.

*Keep the kids out of the pool halls* was a sort of national crusade, espoused from pulpits and political podia. Did the nation experience a new burst of sanctity as a result of saving its youth from exposure to nine ball and snooker? Certainly not.

It turns out that pool halls offered many advantages to boys who were on their way to becoming men. In a pool hall you learned to respect your elders, to speak only when spoken to (and then to speak politely) or be prepared to defend yourself. You learned how a fool could throw away his hard earned paycheck in a few minutes of misguided bravado. And you learned that the laws of motion are pitiless: no matter how hard you pray, if you hit the ball wrong, it went wrong.

Were we youngsters saved from knowledge of gambling, smoking, foul language, and s-x (as it was spelled in those days)? Don't be silly. In that era of short and therefore frequent haircuts, we learned more about illegal betting, foul language, and girlie magazines in the neighborhood barbershop than we would have in a pool hall. We would have been better off, morally, shooting pool and letting our hair grow.

Now we have a similar situation arising with respect to videogame arcades. The same fears among the parents. The same desire to protect their children from the evils of this world.

First, let us understand one thing. Many of the protestors simply don't want videogame arcades in their neighborhoods because of the noise, traffic, and bustle of crowds thronging around the place. That's understandable.

But the adults are missing a crucially important point. These adults fear that school-aged kids will play videogames when they should be doing their homework, will

spend their lunch money on videogames instead of the nutritious meals offered at the school cafeteria, and will be exposed to most of the same influences from which they themselves were "saved" by their parents.

To blame a videogame arcade for a child's lack of discipline is not only wrong, it's moral bankruptcy. It is the parent's responsibility to see that the child completes homework assignments, assuming the school gives them homework to do: many don't. To hark back to my distant youth once again, in my neighborhood there was a motto about schoolwork: "You get good marks on your report card or you get good marks on your body." That system required the parents to exert themselves, but most of the exertion was verbal and psychological, not physical.

If a kid spends money on videogames instead of lunch (or, more likely, junk food) that's the kid's decision. They'll never starve. Most American youngsters with enough change in their pockets to play videogames can afford to miss a meal now and then.

But most of all, it is difficult to justify an anti-videogame attitude among people who are also worried about the quality of education in their children's schools.

No teenager is going to learn astrophysics from *Space Invaders*, I know. But videogames are breaking down the barrier between kids and computers. That may be more important, in the long run, than all the boring, poorly-taught courses offered by the local schools.

For thirty years and more, educators have worried publicly about the impact of computers on society. Science fiction writers have built careers around dire warnings of the "de-humanizing" effects of computers. They have depicted computers as soulless inventions that will crush the human spirit. Even at best, they have pictured computers as machines with which only a tiny, brilliant elite will ever feel comfortable while the average human being is pushed deeper into ignorance and poverty by inability to cope with those blinking, bleeping "electronic brains."

Which is all nonsense. If videogames have taught us anything, it is that every youngster exposed to them becomes fascinated by them. Far from fearing the computer, the average teenager or preteen loves to play videogames so much that their parents are terrified by a situation they can neither understand nor appreciate.

So they protest against videogame arcades. In a way, I agree. Let's bring back the pool halls; that's a game my reflexes can handle.▲

**Ben Bova, editor of *Omni Magazine***



# eye on

## A GIANT FLEXES ITS MUSCLES DEEP IN THE HEART OF TEXAS

If Texas Instruments has its way, those of you who know the company only by its calculators will soon be applauding its ambitious push into videogaming and personal computing.

Backed by a \$25 million promotional push, Texas Instruments has sent its TI-99/4A home computer amongst us. In addition to processing data and helping you plot your personal finances, the computer accepts a large library of game cartridges. Naturally, these videogames do not work with any other computer or game system.

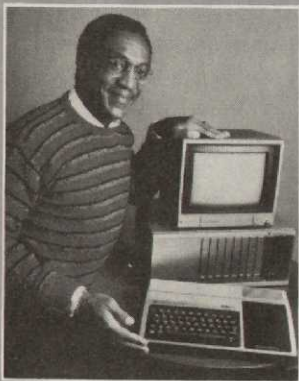

Why buy from Texas Instruments? Corporate spokesperson Bill Turner provides the simple answer. "Quality technology. We've got the best hardware, and our software represents not only brilliant graphics but high utility, a broad range of applications for all ages."

Turner's enthusiasm about his company's hardware is justifiable, though game-for-game Texas Instruments is not going to cause any trepidation in the halls of Silicon Valley. Early releases are well-done, though many are familiar. To wit:

*TI Invaders*: five racks of descending aliens, a mother-

ship soaring overhead, four shields, three missile firing bases.

*Munchman*: four hungry Hoonos chase Munchman through a maze while he tries to swallow down dots. (Aware of the fate of *K.C. Munchkin*, Turner says that Texas Instruments submitted *Munchman* to *Pac-Man*'s representatives, from whom they have had no complaints.

*Car Wars*: you try to drive over dots while a killer car pursues you through a symmetrical maze.

*Hidden Numbers*: match pairs of numbers concealed in rows of squares.

Among the more inventive cartridges are *Starship Pegasus*, in which you must conquer or ally yourself with alien worlds; *Tickworld*, the pursuit and caging of eight giant ticks; *Ships!*, a realistic recreation of the art of sailing, in which you react to wind changes, typhoons, and collisions; and *Maze of Ariel*, wherein you use grenades to slay dragons.

Turner does not disguise a slight disdain for the public's preoccupation with videogames. In his judgment, the primary value of these games is to make people comfortable with personal computers. This is the reason Texas Instruments has produced videogames for a personal computer rather than for an Intellivision-like console.

"Through the games, people will discover the many educational applications of our TI-99/4A, as well as its capabilities in terms of banking, Tupperware or Amway management, keeping su-



permarket lists, helping with homework, that sort of thing. Our pitch to the public is that Texas Instruments is producing a sound, high-caliber investment for the entire family, one which does everything *including* games, though not *exclusively* games."

One of the innovations which Turner promises for the near future is the capacity to play Texas Instrument videogames over the telephone. "You and a friend will be able to entertain one another without having to go to leave the house. That's sure to cut down the frustrations of parents who are tired of being bus services. However," he laughs, "it will *increase* the headaches of Ma Bell when they try to decide whether or not to charge flat rates for this service."

(A representative for A.T.&T. told *Videogaming Illustrated* that the phone company expects to make special accommodations for over-the-phone videogaming. Rather than charge players for a full game — chess, for example, can last for hours — a new connection will be made for *each* impulse. The total charge will therefore be nominal.)

Turner is confident that the personal computer approach to videogames is ultimately the one the public will embrace. "Even if all that people want to do is play games, there's no way

that a videogame console can match the graphics or memory of a computer."

An impressive, hands-on display featuring the TI-99/4A and its games can be seen at computer and department stores around the nation. Retailing for under \$400 — roughly the cost of the comparable Atari 400, Radio Shack TRS-80, and other computers — the unit is sure to add spice to the already brimming competition for buyer dollars.

## DON'T THROW AWAY THOSE OLD ATARIS.

Even if Texas Instruments lives up to Bill Turner's augury, there are at least two good reasons to hang on to those trusty old Atari Video Computer Systems.

The reasons are *Pitfall!* and *Megamania*, a pair of videogames which Activision will ship next month.

In *Pitfall!*, the player is Pitfall Harry, described by the company as "Part maverick, part soldier of fortune." Harry is on a search for hidden riches, en route to which he crosses crocodile-infested swamps, tar pits, fires, and concealed passages which can drop him into the laps of killer scorpions. This videogame

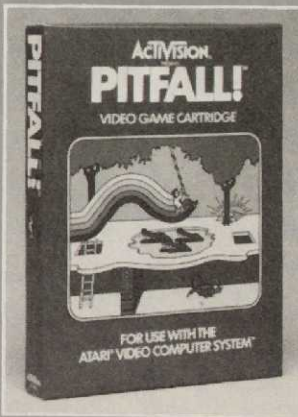



# eye on

is the sinister brainchild of David Crane, creator of *Freeway*, *Laser Blast*, and others.

*Megamania*, subtitled "A Space Nightmare," is nothing less than that. Steve Cartwright, who sent us soaring with *Barnstorming*, has designed a Dali-esque contest in which hamburgers, tires — radials, mind you — dice, irons, bow ties, and other everyday objects bombard the player's guns with missiles.

*Megamania* and *Pitfall!* represent the seventeenth and eighteenth games from Activision. Presuming we survive these cartridges, the next two will be out in time for Christmas.

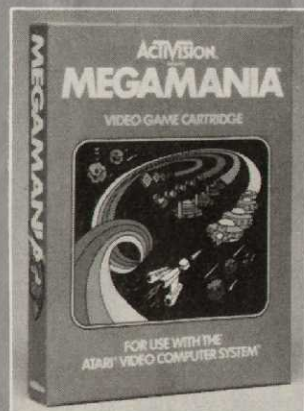

## "CATCHING UP RAPIDLY..."

"Thanks to our new cartridges we're catching up rapidly on Activision and Atari."

That's how one Apollo publicist describes the public's reaction to *Lochjaw* and *Space Cavern*, the company's most recent releases. Indeed, the only downbeat news from Apollo is the decision to change the name of *Lochjaw* to *Shark Attack* on the heels of legal saber-rattling from powerful Universal Pictures, producers of the motion picture *Jaws*.

But, undaunted, the company is planning for the fall release of two new videogames, tentatively titled *Blue Angels* and *Cosmic Combat*. By Christmas, two additional games will have been shipped, as well as cartridges for use with Intellivision. The latter will include the new titles as well as a selection of Apollo's earlier games.

At the moment, six companies have produced a total of eighty-three cartridges for the Atari console. Will the glut discourage newcomers? Not on your life...

## GABRIEL'S HORN SOUNDS

Seven is traditionally a lucky number, but the latest entry into the videogame marketplace has more than luck behind it. It has the multimillions of CBS Inc.

The corporate giant has signed a four-year agreement with Bally to produce home versions of that company's arcade attractions. The new cartridges will be released through CBS' Gabriel Industries toy division and, of course, will be compatible with the Atari console.

Analyst Les Isgur of Paine, Webber predicts that the marriage will not enjoy great success because "Every game that has been successful (in the arcades), Atari has exclusive rights to for home video."

Maybe. But CBS' agreement calls for exclusivity on all games that Bally has in development, which means hits-to-come will automatically go to Gabriel, not Atari.

The public will be able to judge for itself in a few months: A CBS spokesperson says that the first three

games will be on-sale in time for the Christmas season.

Eight-four, eighty-five, eighty-six...

## PAC-CARDIOLOGIST

We've been warned that videogames are going to cause the downfall of our culture. Now, it seems, videogames are also going to cause the downfall of our bodies.

According to studies conducted by the University of Nebraska Medical Center and reported in *American Health Magazine*, videogame players pursue their hobby at great personal peril. Research indicates that within moments of beginning play, the bodies of some enthusiasts respond with heart activity similar to those of an athlete in action.

The problem is not in this reaction per se, but the fact that it is not being drawn off by physical activity. "If you don't take it out on a playing field," warns Dr. Robert Eliot of the medical team, "you take it out on yourself."

Eliot admits that the number of people who will actually suffer a stroke as a result of videogaming is small. We submit that attacking your opponent or kicking the Trinitron might ensure your survival in the midst of excessive pressure.

## ON THE OTHER HAND...

Attorney Tom Trapp doesn't feel that we're in any danger from videogaming. Quoted in *Redbook Magazine*, the arcade fanatic suggests that our bodies will evolve to accommodate gameplay.

What the San Franciscan

envisions is a race of humans with enormous bug-eyes to keep track of everything on the screen, fingers whose nerves are extremely sensitive to react instantly to developments in the game, and ears which are hooded to keep us from being distracted by the noise of people around us.



## Is this how the well-accoutered videogamer of the future will look?

Trapp may be right, though the only anomaly we've noticed is a kangaroo pouch grown by some people for storing those nagging quarters...

## AND THAT'S NOT ALL!

While Attorney Trapp is busy extemporizing, science fiction writers are hard at work creating ingenious stories which detail the impact they feel videogames will have upon humanity.

Typical of this new branch of literature is the short story "Peg-Man," which was published in a recent issue of *Isaac Asimov's Science Fiction*. Written by Rudy Rucker, "Peg-Man" is the tale of one Rhett Lyndon, change-maker at Crasher's Arcade in the Killeville shopping mall. Lyndon is undisputed master of the titular attraction *Peg-Man*; unfortunately, this happy talent gets him into deep trouble with



adversaries whose identities are hidden in the story's acronymic title.

There is however, no truth to the rumor that literati specializing in this genre have taken to calling themselves literatari.

## WHEN DOES SNOOPY GET INTO THE ACT?

Prose, of course, is not the only medium to be affected by the videogaming boom. In our last issue we told you about comic book superheroes who are the subjects of videogames, characters such as Superman and Spider-man.



**A member of the comic book team-of-the-future, the super scientific Atari Force.**

Looking around, we noticed that the inverse is also true: more and more videogames are making appearances in the funny pages.

Take, for example, a recent *Funky Winkerbean* Sunday comic page. The setting was a TV talk show and the subject was *Pac-Man*. Addressing the home audience, Senator Noah Vale advised young people to "take up bowling (getting) out of the arcades and into the alleys."

Not so civic-minded is Wonder Woman, who indulged in the fictitious *Commander Video* game in her comic book — although she had to admit, "Hera help me! I barely watch television or even care to play games." More central to plot development were videogames created by the wealthy assassin Arcade to menace Commander Rann and other diminutive superheroes in *The Micronauts*.

But the most ambitious melding of comics and videogames has to be Atari Force, slick, forty-eight page comic books which salute the scientists of the Atari Institute, the foremost center of learning and technology of the year 2005. The team's first four adventures are chronicled in magazines packaged with the *Defender*, *Berzerk*, *Star Raiders*, and *Phoenix* cartridges, respectively.

We've taken the liberty of sending a certain Mr. Schulz Astrocade's *Red Baron* cartridge, hoping to inspire the ultimate symbiosis.

## LIFE IMITATES ART

Naturally, there are some people who take their comic books very seriously.

Two such people are Mike McClelland and Gary Gulette, owners of Captain Video's Games in Los Angeles. The mascot of their arcade is Captain Video, a flesh-and-blood superhero costumed in black and red tights with a glittering cape, insignia, boots, and helmet.

Playing the good Captain is thirty-two year old Mike Greene, who dons his exotic threads and makes appearances around town to promote worthy causes.



**The original Captain Video hastens to save the world.**

But is it really a matter of Messrs. McClelland and Gulette longing to see a childhood fantasy brought to life? Reached at the racquetball club he and Gulette co-founded in 1974, McClelland told us that it is nothing of the sort. The character's purpose is twofold: to raise money for various charities and foundations, and to project a "wholesome and positive" image for videogaming.

The idea is not without precedent. Thirty-three years ago, another Captain

Video strove to prove that his medium was a valuable one, using television to lecture youthful viewers about tolerance, honesty, and personal integrity. In so-doing, he helped to influence a generation for the better.

Then as now, the cause and the words are good ones. Attaboy, Cap!

## WISH-FULFILLMENT

Not everyone has the chance to slip into a phone booth and emerge a dazzling superhero. However, thanks to Datasoft, Inc., you can feel like the possessor of some rather amazing powers.

"Le Stick" is an extraordinary attachment for your Atari videogame, as well as for the Atari 400 and 800 computers, Apple, and others. There's no base to the joystick, only the stick itself capped by an action button. The button is fired with the thumb, while the direction of the on-screen image is controlled simply by tilting the joystick in the direction you want the figure to move. Squeeze the



**The new Captain Video poised atop games at his LA arcade.**



# eye on

pressure-sensitive joystick and the object remains frozen in that position.

Le Stick is a bonafide magic wand, its wizardry accomplished through hermetically sealed mercury switches, which also account for the unusual heaviness of the joystick.

Now, if the people at the University of Nebraska Medical Center are *really* concerned about our well-being, they'll find a way for the mercury-laden Le Stick to take our temperature while we play ...

## WHAT, ME WORRY?

While comic books and videogames seem to be enjoying a healthy synergy, the same cannot be said for an erstwhile comic book.

*Mad* Magazine began its publishing career in October of 1952. Back then it was a ten-cent comic book which parodied other comic strips of the day, everything from Superman to Flash Gordon. Nearly three years later, it became the more sophisticated satire magazine we know and love today.

Alas, according to the magazine's founder and publisher, Bill Gaines, *Mad* has been suffering at the hands of an indomitable foe. "First it was TV taking up everyone's time and attention, and now there's videogames." Gaines, whose

magazine presently sells for \$1.00, is finding that many kids would rather go four rounds with *Donkey Kong* than buy his magazine.

There's an ironic postscript to the story, one which could cause even *Mad's* perennial grinner Alfred E. Newman to weep. The magazine is owned by Warner Communications, the very same conglomerate which owns Atari.

## EASY COME, EASY GO

Last issue, we told you about a computer science student who tallied nearly three million points in *Pac-Man*. Well, his record has been shattered by another arcadist, one Mitch Klappa, age twenty, of Milwaukee, Michigan. His score? 3,183,440. He claims he would have made it all the way to four million, had his arm not given out. At least *this* time it wasn't the machine which went to pieces.

While we're on the subject of high scores, here are just a few of the current records for various arcade games:

<i>Asteroids</i> . . . . .	40,101,910
<i>Missile Command</i> . . . . .	51,957,175
<i>Battlezone</i> . . . . .	5,205,000
<i>Centipede</i> . . . . .	2,999,999

## ABC's

We all know the ABC's — Atari, Bally, Coleco, and so on. Well, make way for F, or rather the *return* of F.

One of the industry's first videogame systems, Fairchild's Channel F was introduced in 1976 and discontinued just over a year later. Never mind the 400,000 people who had purchased units: Fairchild

Electronics had no desire to go head-to-head against Atari, which was being financed by its wealthy parent corporation Warner Communications.

Enter Zircon International. Late last year the company purchased Fairchild's stock of videogame hardware and software. They also put into production the prototype Channel F II, an advanced unit which Fairchild had developed but never marketed; the system is now appearing in stores nationwide. Remarkably, the console sells for under \$100.

Consumers who are just discovering Channel F have a fine sampling of games from which to choose, including *Blackjack*, *Desert Fox*, *Cat and Mouse Maze*, *Spitfire*, *Hangman*, *Baseball*, *Torpedo Alley*, and so forth. The graphics on all are comparatively primitive, but Zircon will be reworking many of them for the Channel F II system.

In the meantime, the company has produced four new games which are of Atari-quality: *Alien Invasion*, *Casino Royale*, *Pro Football*, and a dual cartridge featuring *Galactic Space Wars* and *Lunar Lander*. The latter is a truly novel concept. In the first game, you must battle fast-moving enemy spaceships; in the second, you must land your fuel-depleted vessel on an alien world.

There are twenty-six cartridges in all, with more to come. Each sells for between twenty and thirty dollars. For the price, Zircon's system — which includes its new joystick, previewed last issue — cannot be beat.

After a few rounds of dodging androids and scur-

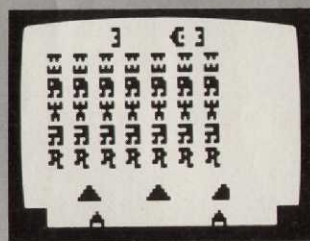

**Alien Invasion, one of five new cartridges released by Zircon International for the revived Channel F.**

rying behind force fields in *Robot War*, we're wondering if *that* can be beat as well!

## TRON JR?

While the world-at-large celebrates the news that the TV hit *Dallas* will be made into a theatrical motion picture — laden with R-rated action and passion — videogamers rejoice at *important* news, such as the computer/arcade-based movies about to go into production.

In addition to *Spaceblasters*, announced last issue, you can look forward to *Star Fighter* which, like its predecessor, is the tale of a young man whose skills at videogaming involve him in an intergalactic conflict. However, unlike his *Spaceblasters* counterpart, he is enlisted not by earth but by an alien world which he must defend from attack.

*Mirror Man*, on the other hand, uses computers in the same way as *Tron*, to create the sights and sounds of another world. In this instance, computer animation will allow the audience to experience the fourth dimension. The film is being directed by Michael Wadleigh, who gave us last year's literate and much-underrated horror film *The Wolfen*.

*Continued on page 60*





# close up

## VIDEOGAMING:

# the inside story

*Your videogame is a computer whose working parts are switches one-millionth of a meter wide and molded primarily from silicon — sand! Amazing? It's just one of the wonders which bring videogames to life.*

*by Martin Levitan*



**T**he TV comes hissing to life.

A game is selected, objects begin to move on the screen. The joystick responds to your touch while buttons cause cars to gas up or bombs to drop.

The action is fast, colorful, and noisy. It seems to "just happen."

That's not true, of course; spontaneous generation has been in Dutch since the days of van Leeuwenhoek. Like any scientific device, videogames are designed, programed, then manufactured to work within the meticulous laws which govern your console computer. From conception to actual play, the byword in videogaming is *order* — organization which allows us to create chaos on the TV screen!

At the centerstage of videogaming is the TV itself. During gameplay, it works the way a TV set ordinarily works. The on-screen action is a series of still pictures, sixty of them flashing at us every

second, our eyes combining the individual frames into one moving picture.

Each of these separate pictures is painted by electrons. Spit from a gun in the back of the TV set, the particles strike a tube which is coated with material that glows when hit. The gun rapidly scans the screen in a series of 192 lines, each of them containing up to 280 points; thus, a single space invader can be made of as many as twenty electron concussions.

This process creates both black and white and color images. A color TV is somewhat more complex, possessing three guns — red, green, and blue — the coating on the screen divided into layers, each of which is sensitive to one color only. Again, our eyes help make the illusion work, combining the colors to create up to sixteen distinct tones.

The images which appear on your TV during videogaming originate inside the

console. If you're curious enough to follow along, turn the unit upside down, remove the corner screws, and open it up. (Congratulations! You have now voided your warranty.) In the middle of the console is a big connector where you insert your game cartridge and through which it communicates with the console circuitry. Off to one side is a large rectangular box, the power supply. Don't touch it: the pack's capacitors can give you a nasty jolt even after it's been unplugged. Suffice to say the unit's job is reducing the current found in household wiring to levels which won't melt the computer's delicate plastic-encased micro-electronics. It also provides the electronic drumbeat which keeps the videogame computer's many operations moving and coordinated.

The green plank is your printed circuit board, studded with black plastic chips. These chips are integrated cir-



cuits, electronic roadways massed onto a piece of silicon. The largest, though only the size of a pinhead, is the microprocessor.

Indulging our imaginations and shriveling to the size of something subatomic — say, an electron — let's take a closer look at what transpires hereabout during gameplay.

The microprocessor or Central Processing Unit (CPU) is the largest chip around, the "boss" chip which executes the game program instructions. If we regard the computer as a city the CPU is equivalent to the mayor, a Tammany Hall czar who ensures the smooth and normal running of events within the realm.

Every action performed by a computer involves instructions which have been stored by the designer or are entered by the player. (See ROM and RAM, below.) These orders are expressed as numbers, the computer's language being limited to ones and zeroes. Each of these numerals is called a bit, eight bits comprising a computer-language sen-

tence called a byte. Simply put, this massive collection of bytes a yes-and-no system, a means for the computer to determine whether each of its myriad switches is to open or close. Countless commands shoot through the computer every second, but if each instruction cannot be stated as a simple affirmative or negative, it's just too complicated for a computer microprocessor to handle.

How does a yea or nay network serve up videogames? Simple. The computer's switches are connected domino-fashion. This means that while the opening of one shuts a path of communication, at the same time it opens another — that path triggering similar reactions up and down the line. This mass of data emerges as on screen images, sounds, etc. Essentially, in lightning-fast progression electrons are asking, "Should I go this way?" each and every step of the game.

As we look around the microprocessor board we notice that its "buildings" are connected by a network of fine silver and copper wires, the local transit

system. The commuters in this city are those electrons which shuttle incessantly between the various locations, setting or unsetting switches and thereby moving information about.

The capacity of the computer to interpret this information is scattered throughout the districts and precincts of the city, in areas called the Read Only Memory (ROM) and the Random Access Memory (RAM). The RAM contains the volatile memory of the system, the transient information produced during gameplay and which disappears when the computer is shut off; the computer city's hotels, if you will. The ROM consists of the instructions and elements of gameplay, the city's stately old homes whose permanently stored data describes the character of the game. The ROM and RAM make certain that your videogame always acts and looks the same (ROM), yet responds to your ever-changing commands (RAM).

Looking at a chip on the sixteen metal pins that connect it to the rest of the microprocessor board — a brief look, lest we find ourselves bowled over by the many messages using the entrance each second — we find this great warehouse organized into distinct areas. Up front are registers where data and instructions arriving from the ROM and RAM memory areas check in. A program counter keeps track of whence the next set of data will be arriving, while the CPU ushers the newly-arrived instructions into the Arithmetic Logic Unit (ALU) where the group is sorted and each member given its assignment. Some wait, others hurry to the display memory area to cue the video image, still others scurry about, returning at regular intervals with information from the joysticks or cartridge.

Rather than duck traffic in this hectic center of activity, we travel to a quieter place, the game cartridge ROM. Here we find the game's instructions, the special symbols, sounds, and rules. Looking around, we notice that its microelectronic switches have been fused open or shut, a function of its ROM nature; this is what causes the game to perform the same way each time we snuggle it into the console. While the cartridge may be asked for further information from time to time, once it has performed its primary function — loading the console computer with information which makes *Fishing Derby* unique from *Yar's Revenge* — it takes a backseat to commands being generated by the players.





When the console has been primed by the cartridge, its so-called "initialization," the RAM allows the video enthusiast to do anything she or he wants within the confines of the ROM. Suppose we have a videogame in which two rocket ships are battling while they flit in and out of an asteroid field. After initialization, the patterns of the rockets and asteroids — whether drifting, thrusting, or exploding — sit around in the RAM area set aside for "objects." Input from the game controls is thereafter decoded to authorize rotation, acceleration, steady motion, laser bursts, explosions, and so on.

Here's a sample scenario. The microprocessor receives input for firing a laser. Switches fly into position building the path which orders a burst to be "painted" by the TV at the coordinates of the rocket's cannon. Concurrently, the computer adjusts other switches so that, from color to sound, every element of gameplay conforms to the present situation. What's more, if the microprocessor detects a coincidence in the latitude of a rocket with the destination of a laser burst, it orders up an explosion by dipping into ROM data for the appropriate circuit pathways to be opened, thus creating the proper graphics and sound description.

When a videogame is in this RAM mode, each of the previously mentioned dots on your TV is answerable to a bit in the RAM. This brings us back to our electron-pelted picture tube. Instead of displaying the input of an antenna, cable, or videocassette recorder, your television is showcasing a videogame. And whenever you move the joystick or press the action button, you're feeding information to the TV through the computer.

The on-screen *placement* of objects — as opposed to their above-mentioned generation — is determined by numerical increments, the joystick or paddle working like a pointer on a scale. Each number to which it ticks adjusts switches inside the computer which control an object's position. For example, let's assume your screen is a giant grid, and that there are one hundred possible locations for an object — a not unreasonable supposition. Depending upon the engineering of your game, shifting the joystick to the left may signal a setting of less than fifty, which will move the on-screen object to some point on the left, grid forty-nine, forty-eight, etc. Nudging the joystick to the right will rattle off the over-fifty numbers, shifting the object



from fifty-one to fifty-two to fifty-three and so on until you allow the joystick to spring back to neutral. This kind of current control is similar to the working of a light dimmer, except that twisting and turning orders an object into position instead of adjusting brightness.

All of the actions discussed in this overview surge through the computer circuitry at a staggering rate. The CPU in a videogame will execute some 500,000 elementary mathematical instructions per second, though components in more sophisticated computers can handle up to ten *billion* commands in that same time. (Nor are scientists content with paltry billions: they're working on supercomputers which will process trillions of calculations per second. Though such technology transcends the current needs of videogaming, it will vastly enhance scientists' capabilities in areas such as weather forecasting.)

As you can see, videogame entertainment does *not* "just happen" the only unpredictables are the outcome of the game and the joys and frustrations experienced by game designers while programming their brainchildren.

Speaking of which, next issue we'll look at what goes on inside the factory and see how videogames are actually created. ▲

### **Peripheral Vision**

***If you think Computer Science is difficult, watch what happens when biology enters the picture.***

Mentioning the noted microscopist Anton van Leeuwenhoek (1632 - 1723) brings to mind his present-day counterparts. However, scientists these days are doing more with microbes than merely studying them beneath a lens: they're planning on using the mites to build computers.

The dream computer is one which would not use switches to flick on and off, but molecules. These tiny objects are extremely flexible, quickly becoming agitated when heated slowing when cooled. They'd make perfect little yes-and-no sentries inside a computer.

The trick is threading tiny wires through this microscopic matter. The proposed solution? Bacteria.

Scientists are currently exploring ways to genetically change bacteria so that they'll build frameworks from protein, skeletons to which molecules would readily hold fast. This process is fundamentally the way nature manufactures chemicals, though it has never been used to construct artificial "life" like a computer.

Is this the first step in creating a sentient mechanical mind? Could be, but scientists insist we won't see such a machine for decades.



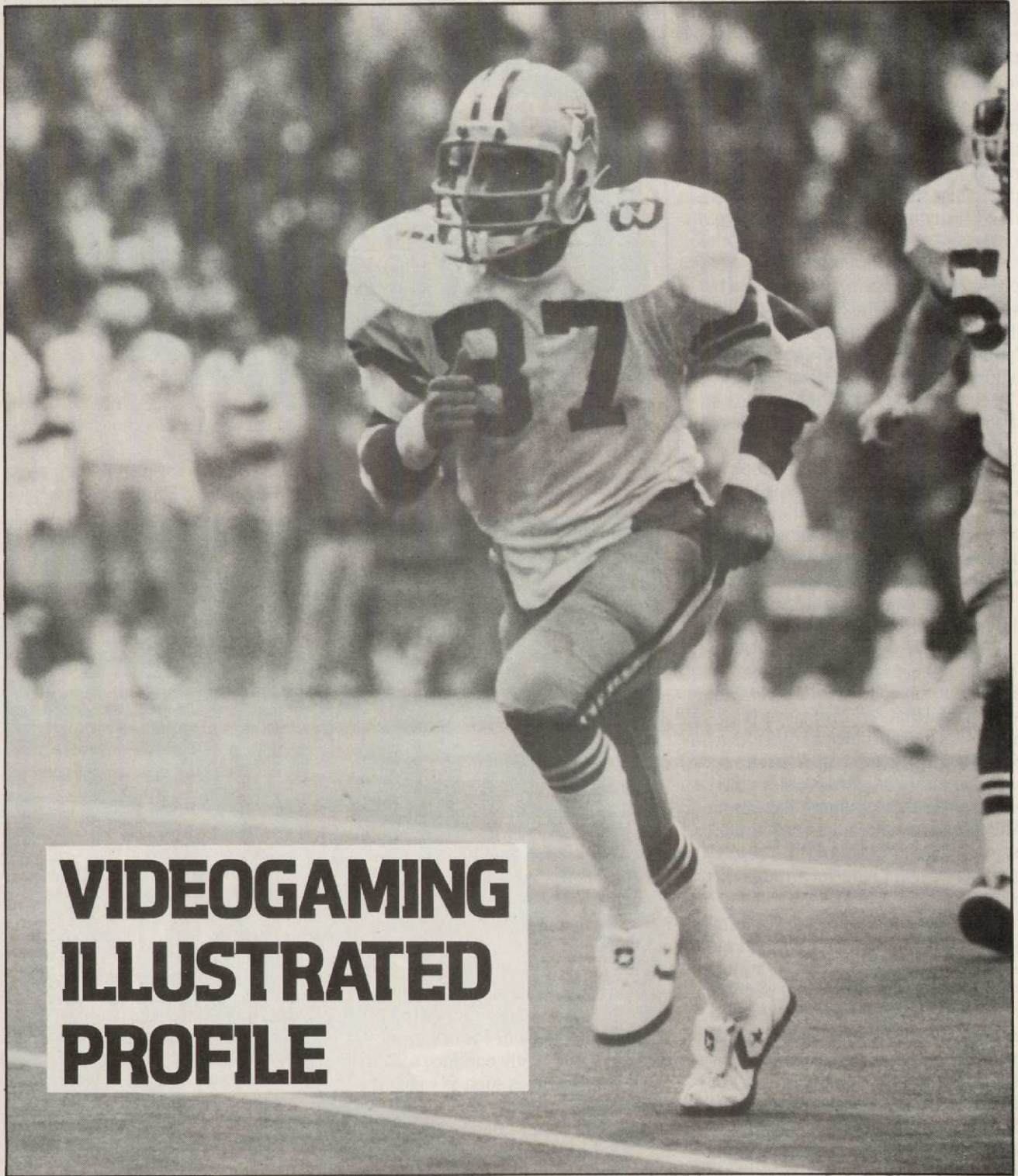

## VIDEOGAMING ILLUSTRATED PROFILE

**J**ay Saldi has been playing professional football for seven years, all of them with the Dallas Cowboys.

Weighing in at 230 pounds, the tight end was raised in White Plains, NY, and attended the University of South Carolina. He played with the Cowboys on one of their

Super Bowl winning teams.

Today, Saldi has a second career, as the owner of two very successful videogame arcades. He spoke to reporter Michael Alexander about the parlors, and about the value of videogaming.





**Saldi and wife at their Arcade.**

Q: It's not unusual for professional football players to own businesses on the side, but why a videogame parlor?

A: The opportunity presented itself and it seemed like a good idea. I bought out a place called Galaxy Videogames. It didn't have the kind of atmosphere I wanted, a family atmosphere. But the location was terrific, in the Town Creek Shopping Center in Dallas, so I reopened it as Cowboy Jay Saldi's Family Gameland. We have forty units.

Q: And you're opening another store —

A: Just opened it. This one has twenty units in it, a pizza palace plus the videogames.

Q: What's the most popular game at Cowboy Jay's?

A: Right now that would have to be *Donkey Kong*, but both *Defenders* are a close second and third.

Q: Do you enjoy playing videogames?

A: Yes I do.

Q: Which one is your favorite?

A: *Defender*. It cost me about \$50 worth of quarters to learn how to play the game, but I like the challenge of it. Now I'm good for at least 75,000 points at a clip.

Q: How do you do on *Defender: Stargate*?

A: Not too good. We've got a kid here, though — we call him Defender Dan — who played the game for thirty-four hours straight. He took a two minute break every hour and scored thirty million points.

Q: Do you personally own any of the home games?

A: I have Intellivision and Atari.

Q: In your judgment, which offers the better football cartridge?

A: Atari's football can't compete with the one from Intellivision. Atari's version is very limited, doesn't really let you become part of the game. Intellivision's maybe a little too in-depth as far as having to punch in numbers to run a play,

but it lets the player be creative. It's just much more realistic. I've also played Odyssey's football, and it's somewhere between the other two where quality is concerned.

Q: Is your arcade a purely financial venture, or do you think you can do some good for the community?

A: What I've been trying to do from day one is create a family image. My place is well-lit and I have two employees working there all the time, three on weekends. It's not a hoodlum atmosphere. Parents drop their kids off and feel secure because we don't have just a college kid sitting behind the counter, someone who can't leave, for example, to supervise the parking lot. I've also made a point of getting games for all ages, attractions for parents and very young children both. When I go over there, I see grandparents playing right alongside the kids, enjoying the games. And that's what it's all about, we're a family gameland. We've also got leagues and tournaments to bring kids together.

Q: What about the less civic-minded game parlors? Do you think those are bad for kids?

A: No. Even arcades which *don't* do the things we do keep kids off the street. Kids are going to hang out somewhere; better at an arcade where they don't allow drinking and smoking than on a street corner. As for people who say the games are addictive, I say better these games than drugs.

Q: How often do you visit Cowboy Jay's?

A: I'm there a lot. Before training camp, I'd work out in the morning and get to the store by 2:30. During the season I still stop by every day, because I only live a mile away.

Q: How many people have come to the arcade not because they're videogame buffs but because they're Cowboy fans?

A: Thirty-five to forty percent, somewhere in there. You can tell. They know a lot about the Cowboys but crash four *Zaxxon* ships in under a half-minute.

Q: You're a hero to many young people, and now a very visible one in Dallas. Does that responsibility bother you?

A: Not at all. I worked very hard to earn it, and I work harder to maintain it since I *want* to present a good image for kids. It's not always easy, because we're all human. I can get angry or frustrated just like anybody else. But when you're in the public eye you owe people your best shot, personally and professionally.

*Continued on page 58*





## The New Learning

by Isaac Asimov

**S**uppose you buy a computer that can play chess with you. You can punch in your move and it will indicate a countermove.

It may not occur to you, when you do so, that you are holding in your hand something that could symbolize a greater change in society than anything for which the steam engine was responsible.

Follow it through.

You like to play chess. You're not very good at it, but you enjoy it. With the computer you can play chess and have a little fun. That's fine, but fun is all you have. It's just a game. What's so important about it?

But consider that for the first time you can play when you want to. You don't have to persuade someone else to play a game because you want to — or fight off someone's importunities when you don't want to.

The computer is at your service and has no will of its own. It doesn't sigh and look pained when you make a dumb move, or sneer when you lose, or make excuses when you win. Nor does it get petty and refuse to play if you lose too often — or win too often. It doesn't even sarcastically ask you if you intend to move before dying of old age when you take a few moments to think out a knotty combination.

You've never before played chess under such favorable conditions. You can take your time. You can even put a game aside and return to it later, for the computer will wait. And if the computer's program makes it no better a chess player than you are, you will win half the time.

In fact, you will catch on to some of the computer's ways of playing, and you will get to better yourself as you learn by experience. Then, when you begin to win most of the time, you can get a better program for your computer.



In short, while you're having fun and while you're playing a game, what you're really doing is learning how to play chess better. It is impossible to engage in any activity with an intellectual content, in an interested and concentrated manner, without learning. When a computer makes it possible for you to engage in such activities on your terms — in your good time, in your way, in an interested and concentrated manner — then how can you help but learn?

The computer is the most efficient educational device ever invented, because it makes it impossible for you not to learn. Teachers can be insensitive, books can be dull, but computers produce a system in which only you count. And you cannot be insensitive or dull to yourself.

At the present rate of computer advance, the time will soon come (always assuming our civilization does not crumble through our own folly) when any household can have a personal computer, with a complex and thoroughgoing system for information retrieval. This implies a number of things.

You can get what you need for daily life — weather information, the specials and prices at local stores, news and sports headlines.

You can get what you need for daily business — stock market reports, office

data letters received and sent out. You can stay home and still do your work at the office or plant, electronically, or even hold conferences by closed-circuit television if your system is complex enough.

Most important, you can get information that you just happen to want for no other reason than that you want it.

The last is the most important factor of all. All the other things a computer system can do merely make easier something we have always been able to do less conveniently. We could always make a telephone call, or buy a newspaper, or go to the office or plant.

But casual information? Curiosity information?

You might have books, but surely not every book in the world. You might go to the library, but it won't have every book either. And trying to find one that might be helpful, and then working through it, could be a difficult enough task to kill the curiosity.

Yet the day will surely come when the world's libraries, the world's entire store of information will be computerized; when elaborate retrieval systems will be established so that key words can, with little delay, produce reference lists and, for that matter, the reference content itself; if the request is specific enough.

If you want to know when Peter the



Great was born — or what the Donation of Constantine was — or what Bessel functions might be — or what the latest information on Saturn's satellites is — or who holds the record for the total number of no-hit games pitched in a career — or how much 562 divided by 75 is —

Why not?

Moreover, one thing will lead to another. An answer may well give rise to further curiosity and take you off on side issues.

Isn't this what a teacher is for at school?

Isn't this what books are for?

No. A book can only tell you what it tells you. If something in it stirs a question within you that the book doesn't deal with, you must find another book that does, and this you may not be able to do.

With your own computer connected to a global computerized library, though, your first innocent question may lead you to longer and longer searches for information. You may end with passages from half a dozen books, which you could preserve as printouts for re-reading at leisure. And even then, you would only deal with the significant portions of books, as the computer, prodded by your questions, referred you to this book and that to suit your needs.

To suit your needs.

You will be learning without even knowing you are learning, because we don't call it learning when we are doing something we want to do, anymore than we call it work. Learning is something that someone else wants you to do according to a curriculum imposed upon you at a place, time and speed also imposed on you. At least, that is what we have been trained to think learning is.

Will computerized self-education work?

There's no way it can fail to work. Self-education has worked in the past for highly-motivated, unbearably-curious, unendingly-ambitious people. Using only occasional books and incredible drive, the Michael Faradays, Thomas Edisons, and Abraham Lincolns of the world have risen to great deeds.

But where is the cosmic law that says the process must be made so difficult that only top-rank geniuses can overcome the obstacles?

Suppose everyone has a chance at any book or at any piece of information just by signalling for it. People with infinitely less on the ball than the

Faradays, Edisons and Lincolns could get somewhere, do something. They would not be geniuses, but they would at least work more nearly at their top, and that might well be very good.

But how many people would want to know anything at all? Aren't most people just blanks?

Not so. People resist learning because they rarely have any chance to learn on their own terms. Youngsters in school are taught unimaginatively, and by rote, matters about which they are not even curious; or matters about which they might be curious, were it not that curiosity was never aroused; or, worst of all, matters in which they were curious, but in which that curiosity was killed.

But then — if people use computerized-information to learn exactly what they want to learn and no more, who's to say that such learning will be of any importance whatsoever? What if hordes of people are curious only about baseball scores, or about the private lives of movie stars?

Even so, one thing leads to another. Baseball scores may lead to an interest in how one throws a curve, which may then lead to a curiosity about the physics of moving bodies. The private lives of movie stars could lead to a serious interest in the dramatic arts.

And if it doesn't?

Then at the worst, we have lost nothing, because all the effort to teach people "worthwhile" things goes for nothing in any case, if the people being taught don't want to learn. Look about you! Every person you see went to school and studied mathematics, history, geography, literature, and all the time-honored subjects — and the chances are, you couldn't scare up enough knowledge among all of them put together to pass a fourth-grade quiz.

Will computerized education create an ingrown culture in which everyone will hunch over computer terminals and be interested only in what they are interested in so that all inter-human contacts are lost?

That can't be. In the first place, not all the things one is curious about can be obtained from information already frozen. There are some subjects that require the outside world — laboratory work, field work, public speaking, drama, sports.

Computer-teaching will not utterly replace conventional teaching, therefore, nor should it. Indeed, students will welcome human interaction more, because

it will not be the only mode of instruction open to them. They will find the classroom more interesting, knowing that anything that arises out of it that piques their curiosity might be amplified by the computer.

In the second place, even if conventional teaching did not exist, computer-teaching would not necessarily build a wall around a student fascinated by his own curiosity. This is not the way it works. We already have a device that is capable of building a wall around a person. The television set has its devotees who will sit passively watching for hours every day. Will this prevent human interaction? It could — but not necessarily.

Few programs have so caught young peoples' entire imagination as "Star Trek." It has become a virtual cult — but it spawned conventions. The first of its kind was thought by its organizer to be likely to attract 250 people: it brought in 1,400. The second was geared for 2,000 and attracted 4,000 — all of them excitedly interested in each other, because they all lived in the same fantasy world.

The enthusiast is sure to be a missionary. Any youngster who, through his exploration of the world of information, finds some esoteric fact, will look for others equally fascinated. Failing to find them, he will try to teach and convert.

That this should be so is exciting indeed. Given enough time, any student who finds he has wrung from a field all that the computer can find, will start trying to make contributions of his own. If interest is sufficiently fierce and curiosity sufficiently unbounded, research will begin.

Yet even after all of this we haven't plumbed the deepest significance of computer-education.

Earlier in the article I said that the advance of computer-education depended on the hope that our civilization would not crumble through our own follies.

One of the follies that would inevitably destroy us all would be that of continuing to allow the population to increase in number indefinitely. Four and a quarter billion people are now on the Earth; and with declining reserves of food, water and energy, the population is still increasing by 185,000 each day.

The world is coming to realize the danger, and the cure. It is necessary to lower the birthrate. Western Europe has practically achieved zero population growth. The United States is approach-



ing it, and China is fighting hard to achieve it. Even the Third World is waking to the peril.

Suppose we do reach the cure. If we have a low-birthrate world-society for the first time in history, and combine it with high technology and advanced medicine, we will also have — again for the first time in history — a quickly aging population. We will have the largest-ever percentage of people who have reached the autumn of post-maturity, and the smallest-ever percentage of people in the spring of youth.

It is something that some might fear, for it is part of popular wisdom that old people are crotchety, querulous, dull and without vision. Only the young, supposedly, are brave, strong, creative, driving, and productive. Will the world, then, having escaped destruction through the bang of overpopulation, retire to a slower and perhaps more harrowing death through the whimper of old age? Are those the only two alternatives that can possibly exist?

I think not. Our opinions of the old are the product of our system of education, which is confined to the young. What's more, this system treats the young so inefficiently that they are repelled by it, escape from it as soon as they can, and then never return to it, viewing it as a hated childishness they have outgrown. We create millions of old people this way, who have no more experience with education than a distorted and hated memory of their childhood. And even if there are old people who somehow would like to learn something — anything — we do not have strong social institutions to accommodate them.

But how will it be with the computerized education that is now dawning in the world?

If it becomes possible for youngsters to satisfy their curiosity by making use of the world's accumulated knowledge through a device that culls that knowledge and retrieves specific items on command, why should it be only youngsters who will use that device? Or even if it is only youngsters who do so at first, because those who are no longer young and have been ruined past reprieve by conventional education, why should the young stop doing so at some fixed age?

People who enjoy golf, or tennis, or fishing, or sex, when they are young do not willingly stop because they reach the age of 35, or 40, or 50, or any age. They continue with undiminished en-

thusiasm for as long as they are physically able to do so.

So it will be with learning.

It may seem strange to place learning in the class of pursuits which we associate with fun and pleasure, but learning is fun. For those who even in our inefficient educational system, find themselves enjoying it, learning is the greatest pleasure in the world and outlasts all the others.

How much more so would it be when education is completely under one's own control, when one can learn what one wants, when one wants, where one wants, and how one wants; when one can learn something today and another thing tomorrow at will; when one can follow the track of curiosity, at one's own speed and choice, wherever it might lead?

While a mind is exercised and refreshed with new interests, it will not age. Death comes at the end, when the physical machinery of the body breaks down and the mind dies with it, still active and vigorous.

Personal computers are with us. We are growing more familiar with them and learning ever better how to use them; and they will be connected more and more thoroughly to the varieties of information potentially available to people.

The result?

There will be greater intellectual depth and variety to humanity than the world has ever seen. It will be an exciting world, a bubbling and effervescent world in which hosts of interests will compete with each other, and human beings will race each other to be the first with a new discovery, a novel idea, a better book, a more illuminating truth, a cleverer device.

They will look back on everything that existed before the age of the personal computer as a time that belonged to the infancy of the human species; and they will consider the personal computer the path to adulthood for humanity.

But when? How much will we have accomplished of all this by the year 2000?

That depends on how much we will allow ourselves to accomplish; on whether we have the good sense and the will to allow our civilization to continue.

If we choose correctly, however, then what change does occur, large or small, will inevitably be (it seems to me) in the direction I've indicated.▲

## AMAZING NEW CANCER OPERATION UNVEILED.



The doctor doesn't cut out anything. You cut out cigarettes.

This simple surgery is the surest way to save you from lung cancer. And the American Cancer Society will help you perform it.

We have free clinics to help you quit smoking. So, before you smoke another cigarette, call the A.C.S. office nearest you.

And don't put it off. The longer you keep smoking, the sooner it can kill you.

**AMERICAN  
CANCER  
SOCIETY**

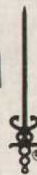

THIS SPACE CONTRIBUTED BY THE PUBLISHER  
AS A PUBLIC SERVICE.



# SUPERGAMING

*Turn the page and  
discover the wonders  
of stroblasting.*





Last issue we told you how to make your videogame sound like the Norse gods clashing in Ragnarok, rumbling the rafters with bass explosions and resonant bleeps.

This issue we add a dash of lightning to your play, a scintillating effect called *Stroblasting*.

Before telling you how to do it, we'd best tell you what it *is*. Stroblasting is a means of triggering a strobe so that the launching of projectiles in games like *Space Cavern* and *Biplane* can be accompanied by dramatic flashes of light.

There are two variations of the Stroblaster. The first is a unit independent of your joystick; the second, which will be discussed next issue — along with an exciting new device — is wired directly to the joystick.

On these pages are the instructions and schematics which will allow you to create a Stroblaster. First, however, a few words of caution.

Unlike last issue's audio enhancement project, this fixture is built without pre-packaged equipment. Wires must be stripped and soldered and electrical hookups made. If you're not familiar with electrical equipment, make sure you undertake this project with someone who *is*.

Here are the materials you will need:

1. A minibox, available for under \$2.00 at any electrical supply store or Radio Shack. This is the housing for the trigger.
2. A nine volt battery and cap.
3. Three yards of stranded single conductor wire, ie #22AWG.
4. A grommet, which can be had for pocket change.
5. A 2200mf electrolytic capacitor, 16VDC, retailing at \$3.00
6. A 22 ohm, 1/4 or 1/2 watt resistor, a bargain at twenty-five cents.
7. One prefocused bulb, PR7.
8. A flashlight, of which you'll discard all but the reflector dish and bulb socket assembly.
9. An inexpensive pushbutton switch (SPDT Switchcraft, for example).
10. Two pieces of wood, roughly 3x3x1 and 3x1x1.
11. A power drill.

### *Building the Trigger Power Unit*

Drill an appropriate hole a half-inch from either short side of the minibox lid. Insert the pushbutton switch, securing it with the nut and lock washer which are part of the unit.

Solder the resistor to the normally closed terminal of the switch. Strip the end of a one-inch length of wire and solder this to the common terminal of the switch.

Setting the minibox aside for a moment, it's time to twine a pair of yard-long wires. While you *could* use a two-wire cable, that tends not to be flexible enough for Stroblasting.

Making sure that the two lengths of wire are equal, place one end of each in a vise. Insert the other ends into the chuck of the drill — from which the bit has been removed, of course. Turn on the drill and the wires will automatically twist together. Strip each end of the two wires. Solder one to the normally open switch terminal.

Using any of the popular "super glues," cement the capacity to the inside of the minibox lid. Do so below the pushbutton, and close to the long wall. Make sure there is sufficient clearance to slide the cover onto the base of the minibox.

Solder the end of the second twined wire to the negative terminal of the capacitor. Attach to the positive capacitor terminal the one-inch length of wire previously soldered to the common terminal of the pushbutton.

Although you can glue the battery in place, this makes it difficult to remove when you want to insert a replacement. It's best to secure the battery using a swatch of double-backed foam — the same adhesive which came packaged with your videogame to fix the antenna connector to your TV. Nestle the battery right beside the capacitor.

Two connections remain to be made. Strip the ends of the wires which are part of the battery cap. Affix the red (positive) lead to the floating end of the resistor, the black (negative) lead to the negative terminal of the capacitor. Drill an appropriate hole at the end of the box, away from the switch, and insert the grommet. Run the twisted two conductor cable through the grommet hole.

(If the box you purchased is made of plastic, there is no need for the insulating grommet.)

The trigger power unit is now com-

plete. Close up the minibox and move on to the Stroblaster.

All that remains is to slip the grommet into the 3/16" hole you drilled, and feed the twined wire through it. The rubber grommet protects the cord from the metal edge of the hole so that it doesn't scrape and short. Knotting the wire before slipping it through will preserve the soldered connections from accidental dislodging.

The trigger is now complete. Close up the minibox and move on to the Stroblaster.

### *Building the Stroblaster*

Using glue or nails, mount the smaller piece of wood to the center of the larger one. You'll end up with a squat looking "T" with a long crossbar. Screw the reflector to the shorter piece of wood, drilling a hole through the dish itself. Screw the lightbulb into the reflector.

The remaining ends of the twined wire should be soldered to the Stroblaster, one to the back of the bulb socket, the other to the back of the dish.

### *Using the Stroblaster*

By keeping the Stroblaster an independent unit, a companion is required to trigger the blasts. This gives your opponent something to do during alternating-turn competitions and can even be worked into your gameplay. Decide, ahead of time, whether your adversary can turn the flash on the TV, momentarily obscuring your view — or whether you, yourself, can be stroblasted if you get too far ahead!

The options are many, limited only by your imagination!

Next issue: triggering the flash with the action button, and a wonder tool to embellish the graphics of your videogame.

*Continued on page 53*

### **A Word of Caution**

Electrolytic capacitors are polarity-sensitive and care must be taken to ensure that the positive side of the capacitor sees *only* the positive voltage from the battery. Should the voltage polarity to the capacitor be reversed, not only will the strobe not work, you will most likely destroy your capacitor.



*The Further Adventures of*

# TRON

*The motion picture  
superstar performed  
some of his  
greatest feats  
off-screen.*

*By Jeff Rovin*





**B**y now, most of the moviegoing public is familiar with the novel jargon of the motion picture *Tron*, colorful words such as "Reco" and "De-rezz." These will no-doubt join the likes of "Droid" from *Star Wars* and *Stranger in a Strange Land's* "Grok" as shibboleths among science fiction fans.

Clever as these coinages are, however, they're "Tronnie-come-latelies" compared to the word we're about

to celebrate, the much-used, long-suffering, "tron" itself.

"Tron" has been around for centuries. A Greek word meaning "instrument," it has taken a back seat since its inception, dynamic but lonely at the tail-end of "neutron," "cyclotron," "electron," and other glossological superstars.

The importance of that little morpheme becomes clear if we try living without it for a moment. Who would

ever take seriously a President's threat to provide NATO with neu bombs (What's wrong with the old ones?), and how much more evocative is mighty "electronic" compared to frail "electric"? A popular science fiction catch-phrase of the 1950s, "Squa Tron," would have been mere "Squat" without "Tron," and even the cultured likes of "metronome" have benefitted from the versatile vocable.

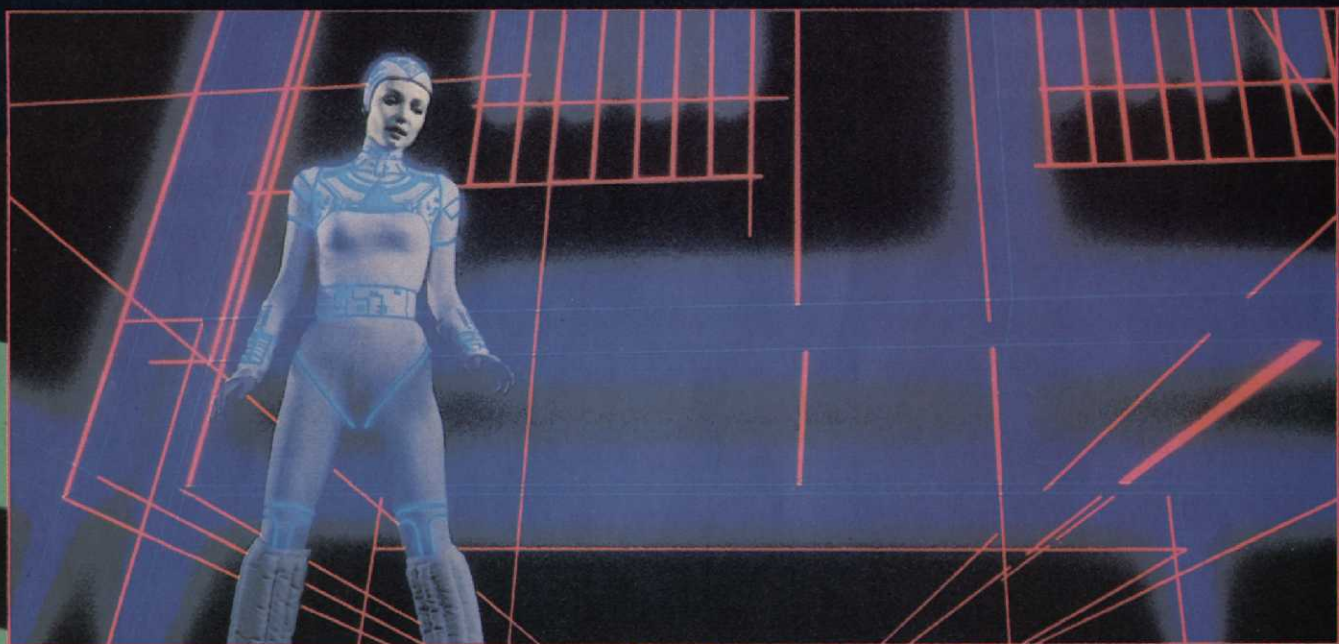

*The only word which applies to events in the world of Tron is "incredible." Here are just a few of the sights, people, and panoramas of the world which exists inside a computer: an electronic guard threatens its captive with an electrical prod, a sting tool used to enforce the will of the Master Control Program; the freedom-loving Yori poses dramatically as her carrier derezzes during a death-defying mission to deactivate the tyrannical MCP; a glimpse of a video warrior and yet... another piece of futuristic hardware; and one of the computer-generated sets combined with live actors in a key sequence from the film, as Tower Guardians escape the MCP tower.*



Over the years, Walt Disney Productions has given legitimacy to such tongue-twisters as "supercalifragilistic-expialidocious," "zip-a-dee-doo-dah," "substitutiarylocomotion," and "bib-bidy-bobbidi-boo." Now they have cast the spotlight on a frequently-abused four-letter word. The studio is to be commended.

One hopes that Sony will soon follow suit, further elevating the dignity of the word by dropping that coy prefix "trini" from all their "tron" TVs ...





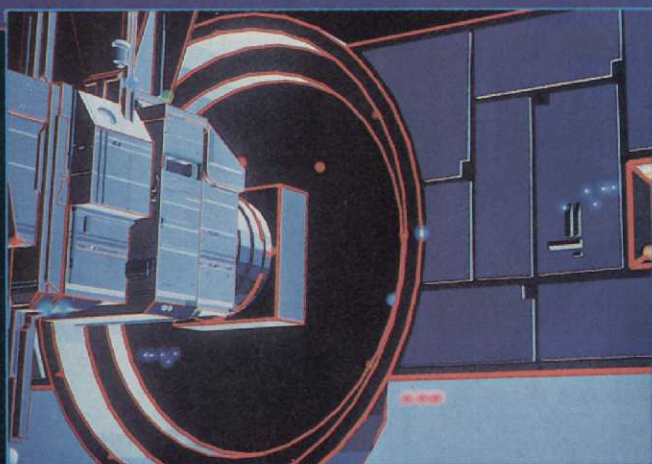
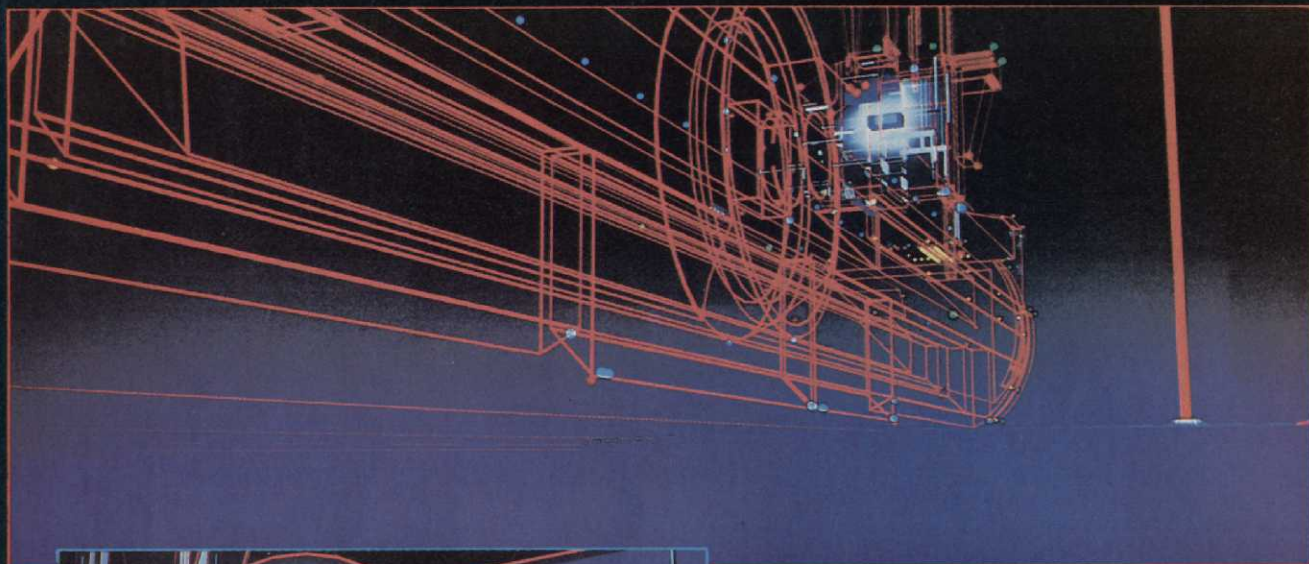

*Tron is a story of humanity and machinery both, as this selection of vibrant images reveals: two views of a derezzing carrier as it approaches the Master Control Program; Tron causing a deadly bead of light to rebound in a battle to the death; and a loving moment when the computer world has been rid of the evils of the Master Control Program. Like all good villains, however, there is no indication that this malfeasant will stay derezzed and disbursed for long. Watch these pages for word on future Disney adventures among the videogame circuits. ...▲*

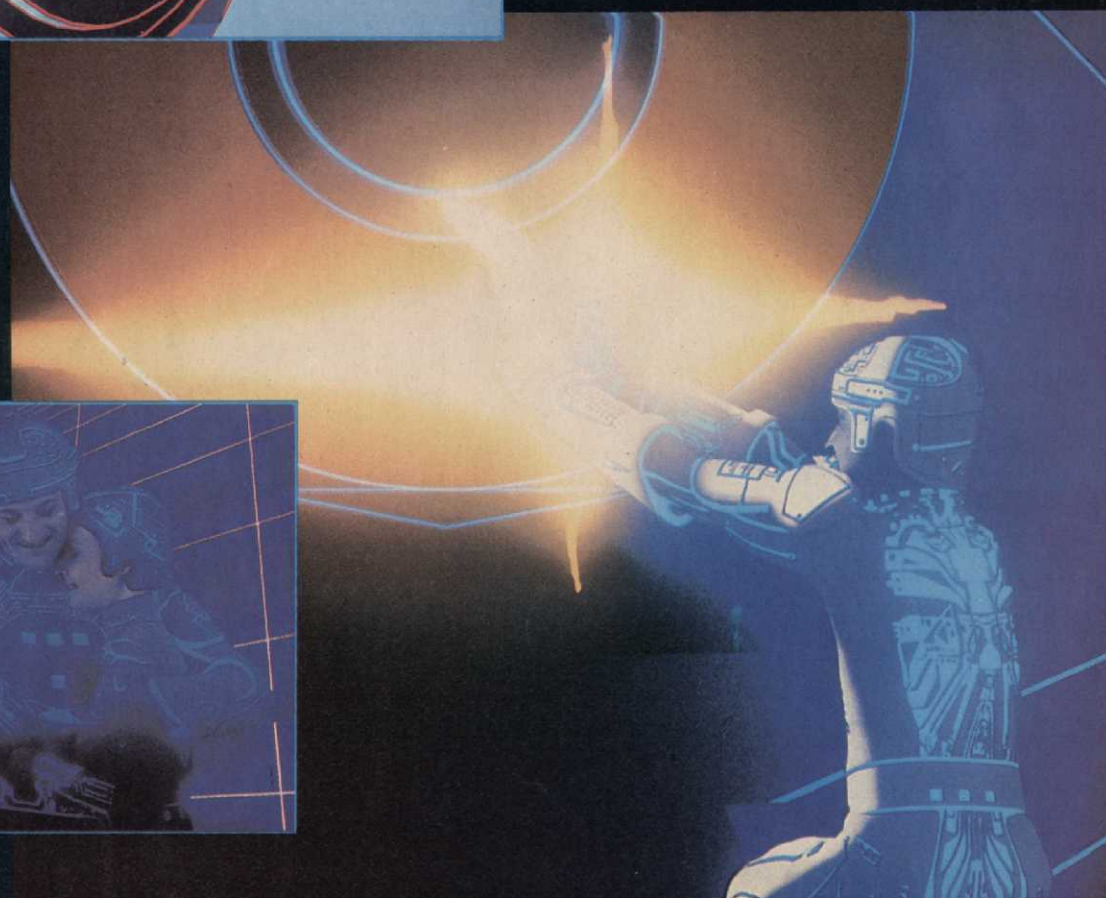



# conquering:



## SPACE CAVERN

**S**pace has been called the Final Frontier, and no wonder. Every planet

on which videogamers set foot turns out to be *their* final frontier, what with lethal aliens and hostile space craft.

The remote planet of *Space Caverns*

is no exception. Teeming with deadly life forms, it can only be survived by stellar explorers who have studied this guide to outsmarting the native life forms.



## Object

Four lives depend upon your skills with a photon ray pistol!

You land your Mark XIV intergalactic starcruiser on a world which orbits a star in an uncharted quadrant of the galaxy. Your tricorder indicates that there is life nearby, located in a network of underground caverns. Donning space-suits, you and your crew disembark.

The catacombs are dark and quiet, even by extraterrestrial standards. One of the men becomes skittish, wants to turn back, but a lady explorer calms him down. The team moves ahead slowly, cautiously, watching to see if video images materialize on the tricorder.

A luckless day this turns out to be: shaggy marsupods do not show up on terrestrial equipment! The eerie glowing creature darts from the walls of the cavern, trying to chomp you with its massive jaws. Since its bite is fatal, you draw your photon pistol — just as gleaming electrosauri come at you from the skies, releasing lethal electro-molecular energy bolts.

The life-and-death struggle has begun!

## Variations

There are forty-eight different games on this cartridge, twenty-four of them for single players. The options are identical, though in the two-player game opponents alternate turns.

*Space Cavern* offers three skill levels: beginner, experienced, and pro. In each, there are the following selections:

1. No marsupods, leaving you to concentrate solely on the electrosauri.
2. Two or four electrosauri, affecting the number of bombs you must dodge.
3. Straight or unpredictable projectiles.
4. The difficulty switch controls the speed at which the electrosauri discharge their electro-molecular energy bolts as well as how fast the charges fall.

## Scoring

There are two sizes of electrosauri, the larger ones worth 115 points each, the smaller ones 165. Blowing away a marsupod wins you 200 points.

Your team is increased by one crewmember for every twenty thousand points you earn.

## Control

*Space Cavern* is a joystick game, although the controls take time to handle with proficiency. You move your spaceperson left and right by tugging the handle in those directions, poking the action button to fell electrosauri.

Plugging the marsupods takes a bit of orientation. To fire *left*, you must push the joystick handle forward; pull back to fire *right*. In neither case is there a need to press the action button.

Until you become accustomed to *Space Cavern*, the inclination is to point your weapon upward by pushing the joystick forward. This will do nothing but fire a discharge at the empty space to your left, causing you to lose the electrosaurus that had been your target.

## Patterns

None of your adversaries is predictable in this game, from the course followed by the bobbing electrosauri to the frequency and location of marsupod attacks.

The only bankable pattern is the location of your space-suited explorer, always entering the fray in the lower right portion of the screen.

A minor bit of information: if your crewmember is slain by an electrosaurus while a marsupod was ambling over, the latter always disappears. The electrosauri remain where they were.

## Strategies

The most important tactic is to stay out of the corners as much as possible. If you're playing a variation which includes marsupods and one happens to emerge by your side, in less than a second you'll be but a fond, masticated memory.

Further, never wait to kill a marsupod. Stop what you're doing and fire. If you're slain by an electrosaurus, you've lost the chance to score big with the other's hide. If you've fired and are subsequently slain, your ray will continue on-course but won't stop the marsupod. Moreover, as the fanged subterranean approaches it boxes you into an ever-smaller section of the screen. That makes you much more vulnerable to electro-magnetic bombardment.

Your strategy, then, should be to move at once to the middle of the screen. Do so quickly but not blindly: if you loiter in the corner, you may get electro-magnetized, yet if you rush madly toward the center you might just walk into a projectile.

Staying within the center-third of the

screen, try to pick off the electrosauri.

Your back and forth movement should be jerky and limited: that is, get out of the way of a bomb then jump back to a position as close as possible to the center. If there's a bomb headed in *that* direction, you must obviously wait until it has exploded or move somewhere else. Just remember: the further you are driven from the middle of the screen, the more likely your demise at the teeth of a marsupod.

While grappling with electrosauri, *lead* the airborne attackers. Run a parallel course slightly ahead of your target until it tries to overtake you — or if there's an enemy heading your way from the other direction. If the former, fire the instant the electrosaurus is overhead, running from beneath it if a projectile has been loosed. In case of the latter, dash ahead and try to pick off the approaching alien returning and resuming your stride vis-a-vis the other.

Be advised that electrosaurus discharges are deadly even after the monsters have been destroyed.

In some variations of *Space Cavern* you can discourage the electrosauri by maintaining a steady barrage straight overhead, though this is not a preferred way to play. Not only does it require no skill, but random bombs will nail you and electrosauri *do* sneak through between even rapid-fire blasts. Besides, when you divert to gun down a marsupod the electrosauri strike with a vengeance.

Above all, keep watching the electrosauri. You will see the marsupods via peripheral vision. As you don't have to aim, blast them without taking your eyes from the flying fiends.

## Comment

These strategies work as well for game number thirty-nine — the most difficult single-player contest — as for game number one, the simplest. Obviously the easier games provide greater leeway for error.

Fans of the arcade game *Phoenix* will find in *Space Cavern* thrills similar to that popular attraction. The flapping of the wings on the small electrosauri as they swoop and peck is especially clever; the beasts *do* seem alive!

This videogame is not only the finest of the Apollo Atari-compatible cartridges, it's arguably the best space game on the market. Certainly it is one of the few videogames which offers levels of play suitable for young children as well as for the best of players. ▲



# conquering:



## PICK AXE PETE

*How to keep from losing your mine.*

### Object

The legendary prospector Pick Axe Pete is busy chopping mounds of ore which roll through the bowels of the Misty Mountain Mine. The mine's many shafts are thick with minerals, but beware! If the ore strikes Pete rather than vice versa, he's a dead miser.

The seven dark shafts of each screen are connected by ladders. These come and go as the coal dust clears, and are the only way Pete can ascend. Getting down is easier: all he needs to do is leap into one of the pits which line each floor of the shafts.

There are countless caverns in the Misty Mountain Mine, each of which boasts seven levels and is accessible through a number of doors. Pete, being a territorial fellow, has locked the three doors in each mine — but, also being something of a thimblewit, he has managed to lose the key that opens them all.

The only time the key reappears is when loose ore collides, which is why

Pick Axe Pete — and the player — must be alert. More on this in a moment.

There is, of course, no way to enter a door without a key. If you try, you'll be caught in the portal and held immobile for several seconds. If a boulder happens to come rolling forth, you're doomed.

The boulders of coal need no keys. They come and go through the doors as they see fit.

### Variations

There are different levels of play in *Pick Axe Pete*. Regardless of whether you start with an easy mine or one laden with pitfalls, each successive mine becomes more taxing.

Depending upon the difficulty level you select — determined by the numbers on the keyboard — the screen will either be the same as you pass through each new door, or more pitfalls will be added. In some, the huge chunks of coal not only roll toward the bottom

of the mine but have the capacity to bounce back *up*, rebounding against the sides of the mine to crush you.

The three doors change to any of eight different colors each time a piece of ore rolls in or out. The color of the door when you enter is the color of the mine in which the game continues. This has no significance beyond decor, though there's a hue — white, black, yellow, green, blue, red, violet, and cerulean — for every taste.

### Scoring

Pick Axe Pete is awarded points for these acts of mining proficiency:

1. One point for leaping over a boulder.
2. Three points for striking a boulder, either gold or coal.
3. Five points for chasing down a new pick.
4. Ten points for catching the key.
5. Twenty points for passing through a door.



No points are granted for boulders which collide and self-destruct, nor for eluding a rock without jumping it.

The player has only one Pete. When he is spilled, the game ends.

## Control

This is a joystick game. Jockeying the handle left moves Pete in that direction, nudging it right sends him right. To climb a ladder, shift the stick up. Jumping is accomplished by pressing the action button.

The trick to effective jumping is positioning Pete's arms prior to hitting the button. Shift his arms so they face the direction you want Pete to go: they are your "weathervane." Moving the joystick up sets his arms like a "V" and he will jump up and down in place. An inverted "V" — pushing the joystick down — will drop him flat on his belly.

An arm can be raised by jerking the stick to the upper left or right, the action button jumping Pete to that side; an arm pointed down will permit Pete to scurry on his belly left or right.

## Patterns

The layout of the shafts changes from mine to mine, and from game to game depending upon which button you select on the alphanumeric keyboard. The shaftways are most difficult when they are invisible, which happens only when Pete enters a *black* doorway. There, pitfalls identify themselves only when Pete tumbles into one.

There is no pattern to the sequence in which the doors change color, or the order in which boulders come spilling from each. Random, too, is the appearance of extra picks and keys. This happens when two boulders collide. One or both of the rocks will vanish: if only one, the other will turn to gold and tumble toward the floor of the shaft. In either case, when both boulders have disappeared, a pick or key is surrendered.

The pick always materializes at the bottom of the mine; the key is always tossed to the top, where it hangs like a sunbeam for just over five seconds before vanishing. If Pete grabs the key even while it is in the process of turning to dust, he can still use it for passage through any of the doors.

## Strategies

Your approach to *Pick Axe Pete* depends entirely on the difficulty level you select. However, except where noted,

the following rules apply to every screen:

1. There is no rush! The trick is to stay alive and garner points. Don't rush after a key at the expense, for example, of having to leap over a door at the top. You may land on a boulder coming out of the other side. Jump boulders until a key comes to where you're standing.

2. The pick with which you start the game disappears after fifteen seconds, Pete being so mighty that the poor tool just goes to pieces. *Don't* bother going after another one. You automatically get a new pick when you pass through a door, so make the higher-point key your objective.

3. While waiting in the top shaft for the key, earn points by jumping whatever boulders appear. The *exception* is when the mine has pitfalls which plunge straight to the bottom. If the pick appears and you can drop directly to it within five seconds — before it vaporizes — by all means do so. Though you'll have to fight your way back to the top, you can't be hurt and you'll be earning points all the while.

4. Don't chase a ladder which descends more than half the screen away. You'll never reach it before it retracts, and only rarely does the same ladder emerge twice in succession. A ladder appears somewhere along each shaft every five-to-ten seconds.

5. Don't limit your pickaxing to the shaft you happen to be in. Jumping up will enable you to poke your pick through the floor of the level above, allowing you to smash boulders overhead — unless they happen to be bouncing, in which case you've got to time your jump carefully. Similarly, crawling allows you to hack at rocks in the shaft below.

6. When you're pickless, never stand in a dead-end corner. You'll jump the boulder, but it'll strike the wall and catch you on the rebound.

7. You *can* climb the ladder below a door without getting stuck in the latter: go halfway up the ladder, then jump the rest of the way left or right.

8. Ladders can be climbed even if they're nearly retracted. Jump at it; making contact with any part will allow you to ascend.

9. If you find yourself on the bottom without a pick, stay there until one appears. There is no sense trying to ascend unarmed, since it will take longer than if you had waited.

10. When you're holding out for a pick or key, watch the boulders on the level above you. Those are the ones with which you'll be contending any moment. Watch the direction they're rolling, and how many are in tandem. This will determine the direction you must jump and the *kind* of jump you make. For example, if two rocks are headed your way *don't* jump straight up or you'll land on the second. Take a vaulting leap toward them. (Don't bother jumping away: you won't score any points, and the rocks will roll after you in any case.)

11. Keep an eye on gold rocks formed in collisions. They're the ones that produce the pick and key.

12. Though you can catch a key while standing in any shaft, only the top level gives you time to run from one side to the other before the key arrives.

13. If you see a ladder retreating, you can get to it faster by leaping at it.

14. Lastly, stay on the move as long as you have your pick. Hop or drop to reach any and all boulders, trying to stay in the upper third of the mine. As soon as the pick crumbles, head for the top level and await the key. Incidentally, you have four seconds from the time the pick begins to chime and scintillate until it vaporizes!

## Comment

Graphically, Pete himself is as amorphous a figure as all the humans in games by *Odyssey 2*. A little bit of "heft" would have been nice, some sinew to give a dash of personality to the brawny prospector.

Conversely, one illusion in which the company has no peer is "bouncing." The boulders roll and bounce as if they were really being affected by gravity. This was an impressive touch in *Odyssey's Basketball* cartridge. But here, with up to five boulders on the screen at a given time, it's sheer virtuosity!

*Pick Axe Pete* offers many challenges not found in *Donkey Kong*, its closest competitor. The player can choose to ascend or not; there is no compelling "narrative" reason to do so. The boulders cannot roll down the ladders of the Misty Mountain Mine, a function of the *Donkey Kong* stairs, nor is there a special effect in *Donkey Kong* comparable to Pete's dramatic passage from mine to mine.

The games complement one another nicely, and fans of one are certain to enjoy the other. ▲



# conquering:



**C**olonizing the inclement depths of space takes more than raw courage and a flexible firing finger. It requires quick thinking — especially when your inter-

stellar mother ship is set upon by fleets of enemy saucers!

The cornerstone of your defenses is ultra-sophisticated radar and the most

advanced weapons in the galaxy. But the strategies which will lead you to victory come from reading this handy little manual.



## Object

While soaring majestically through deep space, your mothership detects an alien presence. Radar reveals five unauthorized squadrons entering the solar system, heading at hyperspeed toward your vessel.

You react according to protocol, sending a signal to urge them back — while you take the precaution of ordering your onboard computers to analyze their strength. There are ten to fifteen attack ships in every one of the enemy squadrons, each sleek saucership armed and bearing down on your position.

They do not respond to your message, and you inform the war deck that hostilities are unavoidable. Your officers are confident, though they know the odds to be grim: the mothership boasts only a trio of squadrons with three ships in each.

But your pilots are good ones, and their equipment state-of-the-art. You turn your eyes to the radar screen and order the first squadron into the fray ...

## Variations

There are four levels of play: beginner, moderate, fast, and advanced. In all but the beginner mode, while you are engaged in combat, squadron against squadron, other enemy units are attacking your mothership.

Because you will be forced to fight on many fronts, your options are:

1. Polish off the ships with inhuman speed and jump from battle to battle.
2. Leave an engagement after weakening the enemy, turning the destruction of the residual invasion force over to the computer while you take on the fresh squadron.
3. Allow the computer to tackle the new assault while you tidy up the old one.
4. Dig out your old *Space Invaders* cartridges instead.

Options two and three are not so much choices as a death wish. The computer is a genuinely lousy shot and will lose one of your defenders for every three enemy craft it destroys. At that rate, you're a certain loser. Better to hone your own battle skills and jump from fracas to fray.

## Scoring

The winner gets to live. There is no point score, only the tally of ships remaining in either fleet. These readouts appear on the bottom of your screen.

## Control

*Space Battle* is played on the Intellivision keypad.

During the adventure's first phase — a radar view of the battlezone — the new game card overlay allows you to select targets, dispatch your ships, and order the battle begun.

Later, when any of your squadrons has been victorious, or if they are urgently needed elsewhere, the keypad permits you to recall them to the mothership.

Once the signal to commence attack has been given, the screen switches to a cockpit view of the enemy fleet. At the same time, control is turned over to the keypad disc and action buttons. The disc rapidly moves your gunsight around the screen, the buttons fire your missiles.

All the while, the other alien squadrons are bearing down on the mothership; on the keypad is a button which allows you to return to the radar view to check on their progress. If you fail to do so, the computer will sound a siren to alert you when a squadron is dangerously close to your mothership. Heed this warning: if the aliens land, the war is finished.

## Patterns

Your mothership is always in the center of the radar screen, the enemies coming at you from the sides. The size and location of each approaching squadron varies in both the radar and cockpit views.

## Strategies

Whatever you do, remain on the alert for those ominous white squares which come flying at your viewscreen. These represent the alien lasers. They can't hurt you until they turn red; when they do so, your ship can be fried. Three such strikes and the squadron is finished. Since red lasers can only hurt you if they hit your gunsight, stay out of their way.

The strategic thrust of *Space Battle* is to lead the alien ships. Nearly a full second is required from the time you fire a missile to when it reaches the target: if you make the mistake of sighting an enemy dead-on, it will have moved by the time your projectile arrives.

Sighting the aliens is dicey business. They very rarely cross the screen in a straight line, nor do they move in two dimensions. That is, they can be traveling up or down, left or right, then suddenly veer toward you.

The key to destroying an alien ship is leading it as soon as it comes on the screen. Fire, then move the sight slightly and trigger an insurance shot if you like — for example, if the ship somersaults suddenly and you fear your first salvo will miss. There is no limit to your firepower. However, it *isn't* advisable to idle in space and see if your handiwork bears fruit. Time is too precious.

You will find that targets are plentiful, perhaps more so than you would like. Therefore, don't bother chasing down a vessel, either one you may have missed or a ship on the opposite side of the screen. By the time you arrive, it is likely to have swerved and be gone from the viewport. *Space Battle* should be played as if it were a child's connect-the-dots puzzle, fighting your way across the screen by moving from ship to ship. (It is possible, of course, to try and anticipate where a ship will go and then outrace it with your gunsight. If you're right, you may tag it. However, playing those odds makes less sense than gunning for a saucer in the neighborhood.)

One of the flaws in the aliens' attack is that their craft often converge, as though huddling before a renewed assault. Watch for this to happen and make an all-out effort to blast the congregation before the vessels disburse. One missile will destroy the lot of them, the explosion of any ship taking the others with it.

The dogfights themselves are actually the simplest part of *Space Battle*. Either you hit the ships or you don't. The real strategy comes into play when dealing with the other four squadrons which are concurrently assaulting your mothership.

Because the computer will lose pro-  
*Continued on page 53*





An aerial photograph of a river delta, showing a network of water channels and land. A vibrant rainbow is visible in the lower right foreground, arching over the water. The sky is filled with white, fluffy clouds. The overall scene is bright and colorful.

# ARCADIA

*The world of arcades, pinball, and other  
coin-operated paraphernalia*

*by Richard Meyers*

**W**ith *Pac-Man* gobbling everything around them and *Donkey Kong* raining barrels on their heads, manufacturers are also being pelted with cries of "Pinball is dead."

"That," says Mark Ritchie, "is a bunch of hogwash."

The speaker is a game designer for Williams Electronics, whose company produces *Stargate*, *Robotron*, and many others. He continues, "It's wrong to say that rather than trying to compete with video we should give up. There are a lot of things we can do with pinball."

Bally was the first to bring the pinball machine into the age of the microprocessor with their *Euel Knievel* and *Night Rider* machines. They also introduced digital scoring to replace old-fashioned chimes and bells with a sound chip which gave players exotic new noises.



Atari came up with a different twist, making the playing fields giant-sized for *Airborne Avenger*, *Time 2000*, and *Superman* — taking the growth to rather absurd lengths in their *Hercules* machine, which could and *did* use a billiard ball instead of a pinball.

*Firepower*, released in 1979, was the first game to use the multi-ball concept, and with it came the first major pinball advance in years. "Having more than one ball in play was considered way before that," Mark Ritchie reveals, "but it was first used in a manner that was really challenging in *Firepower*. You had to *work*, strategically, to place the first ball in a hole which won you the second ball. That was the biggest change to date in pinball."

Gottlieb Amusement Games took another step forward by putting a second level below the main playing field in *Black Hole*, subsequently making pinball a *three* floor experience with their recently unveiled *Haunted House* machine.

*Haunted House* scares up both an upraised section and a sunken one, giving the ball plenty of playing space. To top it off, the entire machine is cunningly designed to incorporate surprises for even the experienced player: two sets of flipper buttons, three trapdoors which drop the ball from one level to another, surprise "kickers" that, when hit, catapult the ball in the



**This pinball attraction scares up a three-level playing field.**

opposite direction with sizzling speed, and several other treats. To complete the package, Gottlieb's artists and technicians housed the game in a devilish console that seems to play a concert of macabre electronic tunes as the ball bounces about.

Another step in the right direction is Williams' new *Hyperball*, which is pinball and a shooting gallery all in one. Bally Manufacturing obviously feels the market exists for such a marriage, since it quickly produced its own, soon-to-be-released version called *Rapid Fire*.



Both machines feature a bright red playing field, Williams boasting a handsome lucite board while Bally touts fluorescent lighting. Both innovations were added in the name of more attractive play to compete with those new vidkids on the block. Lucite offers the added benefit of being especially durable, ensuring that the games break down less often than they break records.

Both companies' shooting gallery elements display hordes of attacking figures framed by targets along the side and across the back of the playing field. The player's job is to smack these targets with tiny pinballs before the lightning-bolt invaders — lights in rows on the playing field — can reach the blaster. Williams dubbed its pinball pistol "Hyper-Cannon," while

Bally has esoterically called theirs "Gun-Mech."

Since Bally produced its *Rapid Fire* after *Hyperball* was released, they were aware of an insistent problem which surfaced in the latter. "Yes," Ritchie says with a sigh, "we're having some mechanical problems with it." The difficulty lies with the vast amount of firepower the machine possesses. The Hyper-Cannon can spit out 250 balls a minute, and they often get in each other's way. Yet, Bally's Gun-Mech sends 480 balls sizzling across the board, and the company insists there will *be* no congestion. The attitude must be one of wait-and-see.

The function of the troublesome Hyper-balls is to fall into holes and slap aside flaps labeled from A to Y. Using two gun-grip triggers, the player has to keep pumping silver orbs into the right places or the aforementioned lightning begins to flash down and drain playing power from the "Energy Center" in front of the gun barrel.

Each bolt that manages to electrify the source saps it of one Energy Unit. If the player allows four more zaps, the fun is all over until more coins are pumped in.

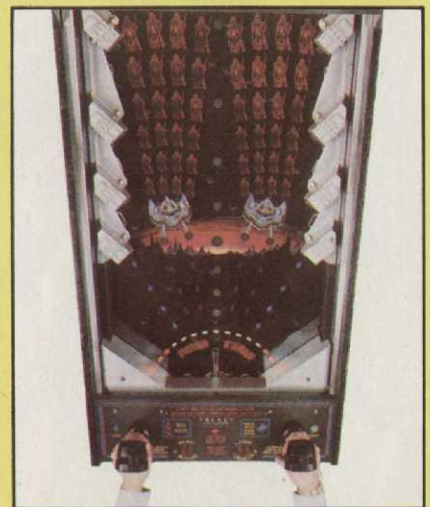

Complicating matters is the Baiter, which not only drains the Energy Center but can also dodge from side to side. To make up for that Williams gives the player three Z-Bombs, which are released with the press of a button and eradicate whatever lightning is on the field.





Mr. and Ms. Pac-Man, Black Knight, and Hyperball are just a few of the revolutionary games with which the pinball industry is attempting to compete with videogames.

*Rapid Fire* gives you more to do but less to shoot at. It also provides the player with a more tangible enemy. You don't bombard lightning bolts but enemy weapon turrets before your foes can march into a pair of attacking spaceships, which send death rays raining down on the Gun-Mech barrel's force field.

As if one didn't have enough to do, spell the word F-R-E-N-Z-Y by pumping pinballs into the corresponding letter holes along the back of the field and the machine awards six thousand points. Bally's Panic Button does the same dirty work as *Hyperball's* Z-Bombs.

The mechanical difficulties with *Hyperball* also include a number of internal problems, such as incorrectly labeled switch settings. However, these have all become moot: for all its trail-blazing the game has failed to set fire at the arcades and is being discontinued.



**“EITHER THIS  
SPACE GAME  
OR MY LIFE  
GOING 10**

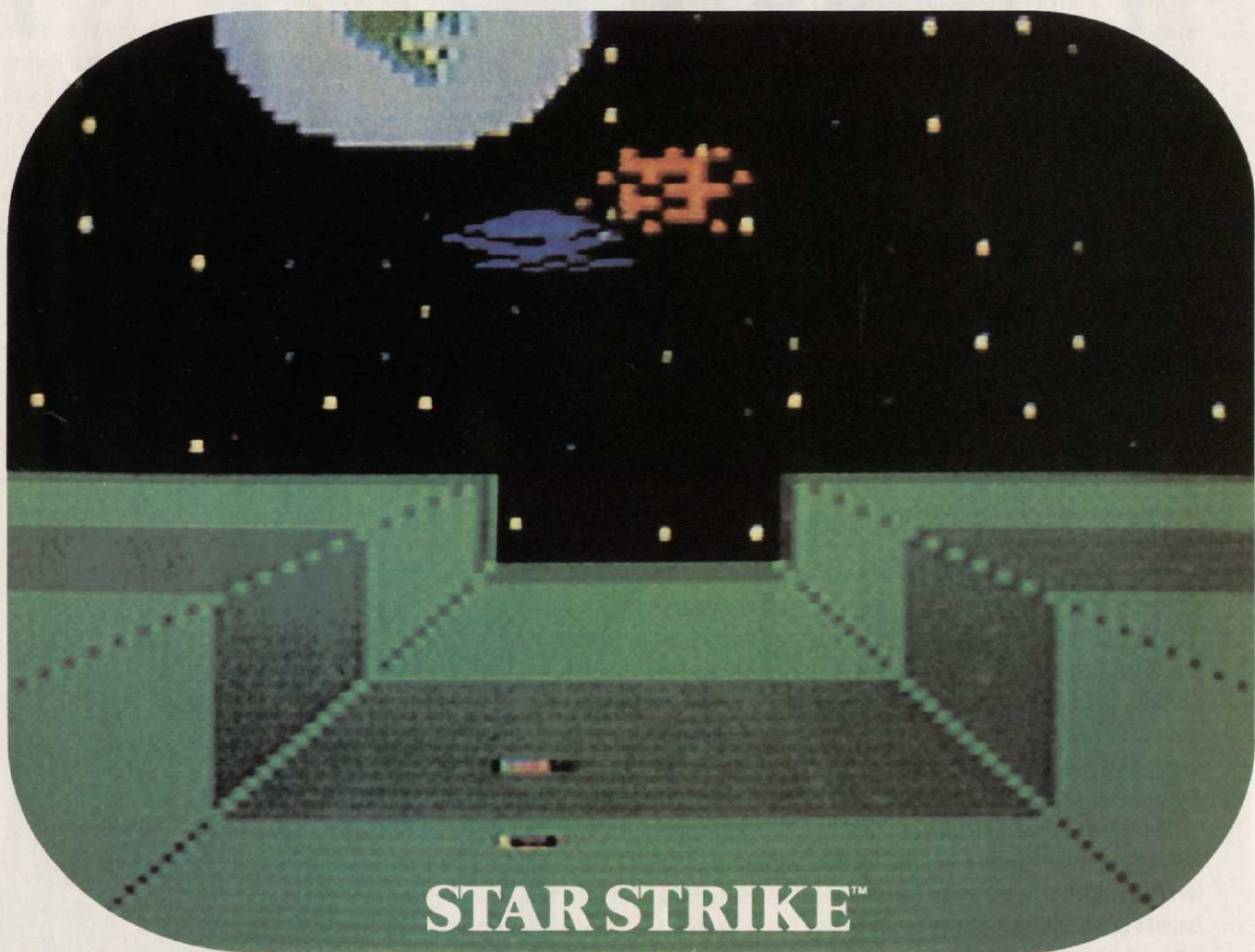



# IS THEIR BEST TIME EVER, THEIR CONTROL ROOM IS MOVING AT 65 MPH?"

Aliens up ahead. Aliens attacking from the rear. Alien ships on every side. Meanwhile, the earth is moving steadily into range of enemy missiles, as the alien planet rushes by below.

Presenting Star Strike™. The exciting new space game complete with brilliant colors, gripping tension, and special effects so realistic they appear three-dimensional. So you almost feel like you're flying.

Be careful, though, and don't lose your concentration. You've got to destroy the enemy planet. Before it destroys the earth.

Play Intellivision® Star Strike. Then, when the battle's over and the dust is clear, compare it to other space games. We think you'll agree that color, excitement and special effects make Star Strike the clear winner.

MATTEL ELECTRONICS®

**INTELLIVISION®**

Intelligent Television



"That's the difference," Ritchie observes. "Pinball is the *real* thing. It has a moving ball, it's an *action* game. Video doesn't have the same physicality, only the simulation of movement." Ritchie also feels that pinball is less insidious than its computer counterpart. "Most of us can accept physical defeat far more readily than ego-crushing mental disgrace," he points out.

There's a little of both in Stern's new winner *Orbitor 1*. Thankfully, the new thrill it provides *more* than makes up for the humiliation one endures at its hands.

After a player has mined the wealth of strategy available to most boards, *Orbitor 1* offers a wild ride to perplex even the most experienced gamer: there is virtually no way to know what the ball is going to do next.

The field is a nearly featureless expanse of cratered and rutted ground. Gone are the nearly naked, big-busted tarts of other games. Gone are cartoon characters, superheroes and secret agents. Instead, all that interrupts the rugged lunar surface are three sets of blue targets, a single yellow spinner gate, and two red bumpers — only they're no *ordinary* bumpers.

These seemingly magical obstructions make the pinball do things no other bumpers ever caused. Instead of rebounding in a neat geometric pattern, the ball defies the laws of physics. Sometimes it nestles against the red padding; sometimes it careens away as if shot from a Hyper-Cannon; at other times it acts the way a pinball is *supposed* to.

When *Orbitor 1* was introduced, mystery surrounded the working of these fixtures. Theories were bandied about, ranging from electromagnetics to witchcraft, but John White, Stern's Field Service Engineer, gleefully reveals that the disks are actually spinners rotating faster than the eye can see.

White was doubly proud to discuss the secret of *Orbitor 1* because it brought up the subject of workmanship. Perhaps the biggest problem in

pinball is frequent down-time. As Ritchie elaborates, "There has to be a way to make a game that doesn't require constant maintenance. If we can do that, then arcade owners will start buying pinball machines again."

Stern hopes they have done it with *Orbitor 1*, whose machinery, like its gameplay, is state-of-the-art. And to further entice buyers, they've included a multi-ball capacity and a unique scoring device that gives away turns every time a new ball is kept in play longer than the last.

Over at Midway, the company that owns Bally, the designers think *they've* found another way to the arcade operator's heart. It's their opinion that the direct route to a buyer's pocketbook might be familiarity. After all, when a movie is successful it cries out for a sequel. *Pac-Man* begat *Ms. Pac-Man*, so what's next? *Mr. and Mrs. Pac-Man Pinball*, of course.

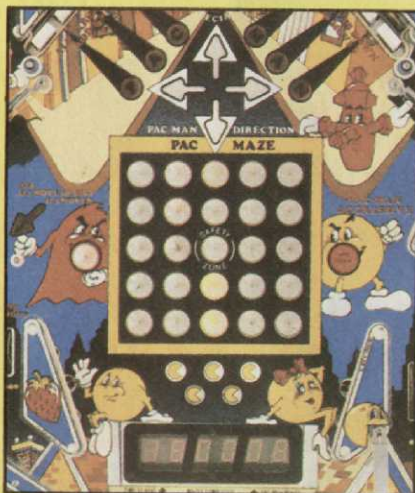

***They may be joined in eternal bliss, but life is far from roses for this arcade couple.***

This time out, a silver ball replaces the ambulatory orb as it criss-crosses a cartoon-covered board. The object isn't just to garner points, but to get what Bally calls *Pac-Man Moves* as well.

In addition to the targets, spinners, and bumpers, this game has a small Pac-Maze composed of twenty-five dots which can be lit yellow and red. The left finger button controls the di-

rection these light up, while the right flipper button handles the actual movement. The object is to try and punch on as many yellow lights as possible before the pursuing red dot catches up with you.

This game is yet another attempt to milk the *Pac-Man* phenomenon, though the Bally designers should be commended for their efforts to combine pinball and video-esque pleasures in one machine. Even so, *Mr. and Mrs. Pac-Man Pinball* pales in comparison to Gottlieb's *Caveman*, truly the world's first pinball/videogame.

The lower half of the unit is regular pinball, but on top is a television set. And nestled before you, on the ledge between the flipper buttons, is a joystick. When the silver ball is propelled into the correct hole, the pinball game stops and the videogame begins.

The object of *Caveman's* pinball challenge is to get points and thus make life easy for the video cave dweller. The object of the video component is to hunt down and kill all the dinosaurs on the screen except for the red tyrannosaurus, who can slay the club-swinging caveman. Hitting the lit yellow targets will replace the tyrannosaurus with pterodactyls, which earn you bonus points when clubbed; spelling C-A-V-E wins you an extra ball. On the videogame side, kill all five brontosaurus and the screen serves up five





triceratops. However, after you kill a dinosaur it transmutes into a tyrannosaurus and begins chasing you. Throughout the videogame portion, the player is thus the hunter and the hunted! Evolution-by-microprocessor will continue for as many screens as your caveman can survive.

From the point of view of an arcade owner, *Caveman* is exciting for reasons other than its novel gameplay. Women are attracted by the board's cuteness and, more important, it's the kind of game which can *only* be played in an arcade. Home video may have boardgame/videogame combinations, and computergaming has *Dino Wars*, but there is no cost-justification in manufacturing a pinball-TV unit for the home. That means more business for the arcades; it's ironic that a videogame may take part in saving an entertainment medium it helped to strand upon hard times!

As inventive and important as *Caveman* is, Ritchie sees it as only the first step toward a future where pinball and videogames can profitably coexist.

"I think there's a way that video techniques and video ground rules can be set up in a pinball machine. I think there's a way pinball players can have just as much control." Ritchie not only talks about just such a hybrid, he's busy doing something about it. His own creation, *Thunderball*, is presently completing its final tests and will be out shortly.

"It's the next big step in pinball technology," he states. "But with or without its success, I see myself making pinball machines. It's a personal love for me, and there are dimensions that haven't been tried yet, either alone or in conjunction with one another: multi-ball, lane changes, more levels, things like that. I've got my own ideas, but I tell you this: pinball is not a wave of the past. When the new games hit, and the video flood subsides, it will be back."

As long as there are creative person-



**One of the more dramatic new games, Williams' Black Knight gives players chutes which provide players with additional scoring options.**



nel like Mark Ritchie, companies like Bally, Gottlieb, and all the others dedicated to the advancement of pinball games; and as long as there are players who want the three dimensional challenge of that little silver ball, Mark's words won't be regarded as quaint nostalgia. His voice will be one of many calling for and demanding an exciting arcade future. ▲

## The Antediluvian Denizens of Caveman



*The Beleaguered Cave Dweller*



*The Awesome Tyrannosaurus*



*The Lumbering Brontosaurus*



*The Tame Triceratops*



*The Soaring Pteranodon*



# alleyway

## Videogaming Beat *Pity the poor arcade owners ...*

They use every method at their disposal to get players into their establishments: they keep the places extra-clean, organized like a boot camp, stock all the latest games, and still there's no guarantee that anyone's going to come in.

Fortunately, there are more than super-pinball games to draw new customers. Video Music International offers arcade owners the stereophonic beat of the best names in pop — and for the patron who is drawn to the rich, full sound of the jukebox, there is an added treat. Video Music International has made it possible for them to actually see in sharp, crisp color their favorite musicians performing a top ten hit, a golden oldie, or a cult classic.

Great Britain has already scooped up more than five hundred "Startime Video Muzzikboxxes," a cunning combination of the traditional jukebox and videotape technology. In answer to this terrific response, company president Jack

Millman has started a full-scale assault on the American market.

"I was completely enamored with the idea of being the first to launch a video jukebox," he says. But initial attempts to create such a device were foiled by the limitations of the hardware and software. People had been trying to manufacture just such a machine since 1945, but they were hamstrung by hundreds of breakable parts and clumsy 16mm film.

Not so the Muzzikboxx. It has benefited from the burgeoning home entertainment industry as well as spaceage microprocessor advances. A top-of-the-line Sony, RCA, or comparable twenty-five inch TV monitor is wired to a Panasonic videocassette player, which has been loaded with a two-and-one-half hour tape. What makes the whole thing work is a patented random access video controller which is produced exclusively for Millman and company.

This unit enables the machine to jump right to the start of any of the forty-eight taped performances selected by a customer. Group W Productions makes up one tape a month for the machines, utilizing the top stars in pop music. The Muzzikboxx's initial offering included a diversity of top talent, such as the Electric Light Orchestra, the J. Geils Band, Sheena Easton, Earth Wind and Fire, Adam and the Ants, Hoyt Axton, and Billy Joel.

Millman says that initial reaction in America "has exceeded even our expectations," and the corporation has worked hard to see that the price of buying and maintaining the unit is comparable to that of any good jukebox. They are hoping that the arcade operators around the country agree with dealers in Video Music International's test markets, that "If music be the food of profit, play on!"▲

—RM





# Astrocade™

THE PROFESSIONAL™

# ARCADE™

# GIVES YOU MORE!



## ASTROCADE BASIC

**MAKES YOUR VIDEO GAME A PERSONAL HOME COMPUTER**

With your Astrocade unit you get an easy to learn basic language programming cartridge and the basic manual which allows you to create your own games, music and video art. You can save your program creations on standard cassette tapes using the built-in audio interface for more fun and for learning more advanced programming techniques.

## MORE FEATURES...MORE EXCITEMENT...MORE CAPABILITY...AND MORE FUN

make Astrocade the best all around value in the video game business! Exclusive features include a 10 memory video display calculator and three exciting built-in games — Checkmate, Gunfight, and the highly acclaimed Scribbling.

### 3 EXCITING BUILT-IN GAMES



CHECKMATE™



GUNFIGHT™



SCRIBBLING™

**REMOTE GAME SELECTION**  
on controller



## MORE EXCITING NEW GAMES TOO!

- Incredible Wizard
- Creative Crayon • Cosmic Raiders • Solar Conqueror
- Artillery Duel • Music Maker • CONAN™
- Bowling • Missile Attack
- Chess • Kong • Haunted Mansion • Soccer
- Pirate's Chase and MORE TO COME!

### ASTROCADE GIVES YOU MORE...

256 color variations, 8-way pistol grip controllers, remote game selection, 4-player scoring and play capability, highest quality realism and fastest action of any home video game, built-in cartridge storage bin, 3-octave music and sound effects synthesizer.

## ASTROCADE Includes FREE Over \$200 Worth of ATARI™ Comparable Options.\*

\*Manufactured under license from BALLY MANUFACTURING CORP.  
\*Data Source: Atari™ 1982 Price Sheet.

## ASTROCADE, Inc.

6460 Busch Blvd., Suite 215, Columbus, Ohio 43229  
Call Toll Free 800-848-6989



# conquering:

## DONKEY KONG



*This issue, Videogaming Illustrated takes a two-part look at the simian sensation called Donkey Kong. In this section you'll learn how to beat the game, how to elevate your score by elevating the brave carpenter.*

*On page 51 our Donkey Kong presentation continues as we look at other gorillas who have had a fondness for women. Prominent among them is King Kong, who has much in common with the video villain.*

*While King Kong and Donkey Kong slug it out for cultural immortality, the public need only concern itself with having fun — starting by helping poor Mario in his pursuit of the shaggy menace.*



In theory, *Donkey Kong* should not be a frustrating game to play. It has only two controls — a four-directional joystick and a Jump button — and the premise is relatively simple: maneuver a character named Mario up and around various boards to reach a certain plateau and save the lovely Nell from Kong's clutches.

Yet *Donkey Kong* is usually quite frustrating, especially for beginners. Playing it successfully requires an elusive "third" control: a sense of timing.

Timing. Knowing *when* to move and *when* to Jump is what separates good players from mediocre ones.

There are four different screens which Mario must ascend: the Ladders Board, the Rivets Board — the final board in any complexity level — the Elevators Board and the Pie Board.

Complexity Level One consists of only the Ladders and Rivets Boards. Level Two begins with a more difficult version of Ladders, followed by the Elevator Board and Rivets; Level Three begins again with Ladders, progresses to the Pie Board and Elevators before finishing up again with Rivets. Subsequent levels always begin with the Ladder Board and end with Rivets. Elevators and Pies are interspersed throughout.

The player begins with the Ladders Board. In the top righthand corner is a timer which tallies points rather than seconds. Play commences at five thousand points, bonus points decreasing as Mario maneuvers around the board. If a player fails to complete any board before the point value reaches zero, Mario drops dead. If the player succeeds, she or he is awarded the number of bonus points remaining on the timer. Obviously, it behooves the player to finish each board as quickly as possible.

(More difficult boards in Complexity Levels Two and up begin with higher timer figures, from six-to-eight thousand, though never more than that.)

Time is only one of Mario's enemies. He can also perish if he's hit by or runs into a rolling Barrel, Fireball, Pie, Anvil, or Oilcan; or if he accidentally jumps or tumbles into a hole in the board. This is *always* a fault of the player's timing.

A look at Figure One illustrates the configuration of the Ladders Board. Mario must climb from beam to beam via connecting ladders, some of which are broken, until he reaches the short

beam on which the helpless Nell is standing.

As soon as gameplay commences, move Mario immediately to the right. Kong will have already started rolling Barrels down the beams to thwart Mario's ascent, the first Barrel being a Direct, thrown straight to the bottom of the screen. That Direct will roll to the left and smash into an Oilcan, causing a Fireball to dance up and follow Mario. However, it is slow and poses little threat to the stalwart player. Chalk it up to a touch of ambiance, sort of *videogame noir*.

Any Barrel which rolls toward Mario is easy to avoid. The player should simply hold Mario in place — leave the joystick vertically neutral — and press Jump as the Barrel approaches. This simple maneuver earns one hundred points.

Sometimes Barrels come in twos or threes. Don't fret: let Mario run *toward* the Barrels, jumping at the appropriate time. This constitutes a Running Jump; Mario can make it over a Double Barrel and, if your timing is spot-on, over a Triple Barrel. The player receives three hundred points for jumping a Double, eight hundred for a Triple.

Whatever you do, don't make Mario *flee* oncoming Barrels. Either he'll be squashed while running or, if you initiate a Jump while he's heading away, Mario will land on top of a Barrel and suffer a spill.

*Donkey Kong's* Barrels not only bounce from girder to girder, but roll rapidly and unpredictably down the ladders. Although many machines have been "adjusted" so that the following trick no longer works, you can try to prevent Barrels from rolling down the rungs by moving Mario up a ladder and stopping him just as one of his hands grips the girder above. On an unadjusted machine, the barrel will roll past; on a "fixed" machine, Barrels roll down the ladder, crushing Mario regardless of his position on the ladder.

The only effective strategy in a situation like this is to keep away from ladders if you see Barrels approaching from the beam above. If a Barrel *does* drop, you'll have time to press Jump, save Mario's life, and score one hundred points.

Regardless of which version of *Donkey Kong* you play, follow the route shown in Figure One.

Note that there are two Hammers, which Mario uses to bust Barrels, scor-

ing either three, five, or eight hundred points depending on the machine's programming. Hammers are plucked from the air by pressing Jump when Mario is beneath one. He can then move left or right, but he cannot move up or down a ladder. Because of this quirk, it's best to ignore Hammer One (the lowest Hammer).

Due to the approaching Fireball, concentrate on getting up the beams to Point A. Here, Mario will have to jump a few barrels after which, as soon as possible, move him left to Hammer Two. Stop and wait for an approaching Barrel and Jump it. Mario will score one hundred points for hurtling the Barrel and he will connect with the Hammer. Continue moving to the right, halting at Point B; give the joystick a tap to the left so that Mario is facing the ladder which connects to the gorilla's beam. Let Mario continue destroying Barrels.

As soon as the Hammer disappears, move Mario up the ladder to the next beam and go left. Jump Barrels until you reach the final ladder, then ascend. You're now ready for the Rivets Board.

Rivets is actually easier to complete than the second stage Ladder Boards. Dancing Fireballs will pursue Mario around the screen, but they are easily outfoxed.

The object of this board is to cause the structure to collapse by removing the eight Rivets (also known as Bridges). Mario automatically removes Rivets by walking or jumping over them.

There are also objects — the girl's purse, an umbrella, etc. — scattered around the board. These earn the player points as Mario walks over them. Your route is shown in Figures Two and Three.

Once a Rivet is removed, a Fireball cannot roll over the gap. Mario can pass by making "running jumps," moving the joystick in the direction of a gap and pressing Jump just before he reaches it. If Mario is poised on the edge of a gap and the player jumps, our hero will only move up and down. As for jumping too early, that will send Mario plunging to his death.

By removing Rivets as prescribed in Figures Two and Three, Mario will trap the Fireballs in isolated spots. To make certain they *are* cornered, immediately move Mario to the right and grab points for running over Nell's purse. A Fireball will emerge from the left or right: after Mario has crossed the purse, move him as shown in Figure Two if the Fireball



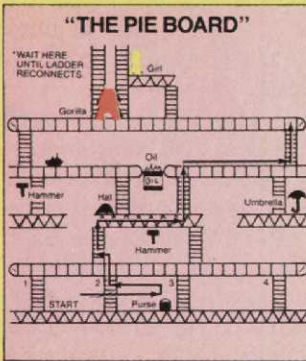
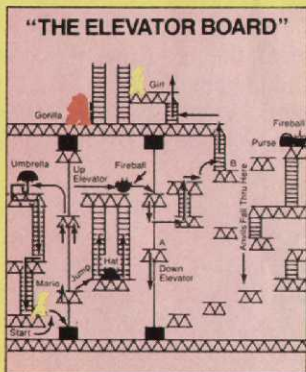
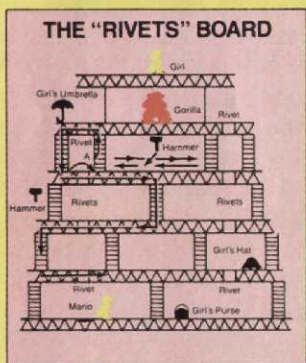
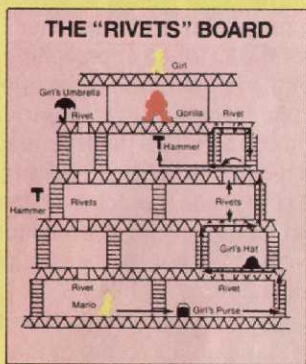
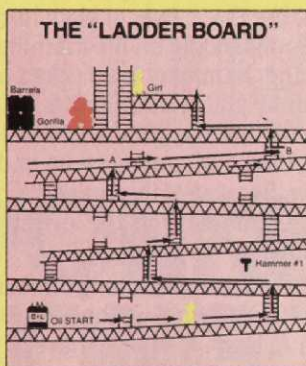

originates on the left. If it hops out from the right, pursue a mirror-image course to the left.

Upon completing the Rivets Board, the player will be faced with another more difficult Ladders Board. This begins Complexity Level Two. More Direct Barrels will be tossed by Kong; in fact, the very first will be thrown diagonally, crushing Mario on the spot if he reaches the first ladder without having paused somewhere along the bottom girder. The player must wait, let the barrel hit the girder, then Jump as it rolls toward Mario.

Although the Ladders Board gets progressively more difficult at higher levels, the best route is that shown in Figure One. The player must obviously be more cautious, keeping an eye peeled for Directs, and adapting to the faster pace set by the machine.

The Elevator Board first appears as the second screen of Complexity Level Two. It is the most difficult board to conquer. There is really only *one* sensible path to the top, and it's outlined in Figure Four. The route is simple; the tricky part is getting on and off the Elevators without killing Mario.

Mario begins his journey on the Elevator Board at Point A. As soon as an *up* elevator appears, the player must move Mario onto that elevator. He cannot be walked; he must be jumped while the player holds the joystick in the appropriate position (to the right at this point in the game).

Once the elevator has taken Mario to the level of the girl's umbrella (along the left side of the board), the player must get Mario off the elevator by holding the joystick left and pressing Jump. Don't simply hold the joystick without signaling for a jump, or Mario will walk right off the elevator to his death; nor should you allow the elevator to take Mario any *higher* than this point: if the fellow hits the top of his head on the rigid block into which the elevators disappear, he'll die.

Once Mario has walked over the umbrella, he must descend by way of the ladders directly beneath it. Once he reaches his original starting point, jump Mario onto another ascending elevator then again to the right, landing him on the double-ladder structure. There he can retrieve the hat, earning more points. You'll notice that once Mario is on the double-ladder structure, the Fireball on the beam above will begin descending toward him. Waste no time moving Mario *up* the opposite ladder

to the top of the beam. Walking to the right, jump onto the descending elevator as soon as possible. By this time the Fireball will realize its mistake and start climbing, but if you can get Mario onto a departing elevator quickly enough he'll be safe.

As Mario descends, jump right from the elevator, landing at Point A (see Figure Four). Climb the short ladder and jump right to Point B. The falling anvils will be dropping just to the right of Mario. Don't worry about them or the purse at the extreme right-hand side of the board; it's not worth the risk!

Ascend the ladder to Kong's level, and between anvils — watch out, they bounce! — rush to the left. Climb the last ladder and head for the girl.

The Pie Factor (Figure Five) is next, and in this board the player should begin by moving Mario right, crossing the base to grab the purse, the backtracking to climb Ladder Two. Mario will find himself on a conveyor belt that periodically brings out Pies — which are, of course, lethal to Mario. Mario can jump the Pies, though it's best to avoid them when possible because they're so wide.

Ignore both Hammers on this board. The one under the Oilcan is difficult to grab (the conveyor belt will cause Mario to slip and slide) and wastes precious moments while the timer ticks points away. The other Hammer is simply useless, since Mario cannot climb while holding a Hammer.

Use the left ladder to go up, then move right, pick up the hat, and climb the next ladder. Mario will reach another conveyor belt which brings out yet more Pies. Worse, a Fireball will flare from the Oilcan to pursue poor Mario.

However, if the player is quick Mario can avoid the Fireball *and* any pies. Move him right, jumping Pies and, as soon as possible, let Mario get a grip on the topmost ladder on the left. Climb it to avoid any additional Pies.

Once Mario reaches the gorilla's level — not that of Nell, who is higher — the board is completed. But beware: the final ladders on both sides periodically disconnect from the ape's beam. Don't move Mario until the ladder reconnects, which it will do after a few moments.

These are the moves to make on each of the boards. Use the same moves on the later versions, even though their speeds make them progressively more difficult. Above all, don't become frustrated! Remember, Nell is counting on you.



# FROGGER™

VIDEO GAME CARTRIDGE

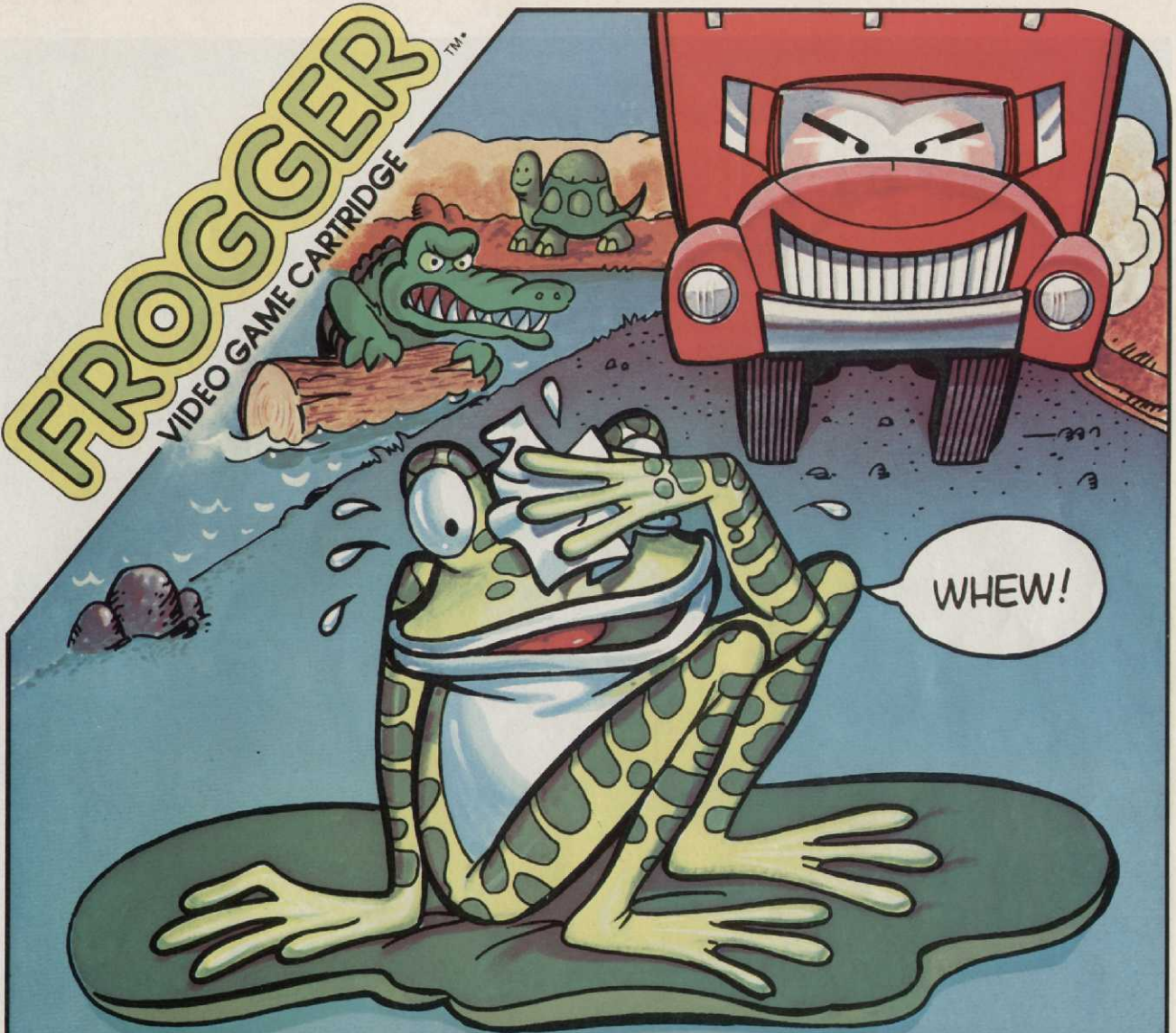

## WE HOPPED FROGGER™ OUT OF THE ARCADE. NOW CAN YOU HOP HIM HOME?

Frogger has just jumped out of the arcades and into your home. Sights, sounds, and all. Do you have the skill to get him to his home?

Frogger's first challenge is to cross a highway where reckless hot rods hurtle by, and huge trucks go thundering in his path. Every safe jump in this maze of motor and metal is a crucial step home.

Beyond is the raging river where the safety of a slippery log or diving turtle is all Frogger can count on to stay afloat.

Frogger's last leap to his lily pad home must be perfect, or it's back to the road to try again. Good luck. Frogger's counting on you.

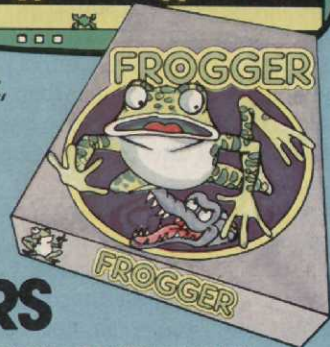
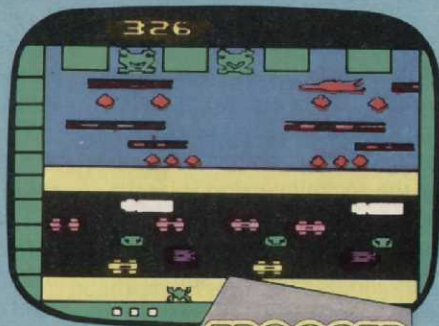

For your Atari Video Computer System™ and the Sears Video Arcade.™

 **PARKER BROTHERS**

FROGGER game graphics © 1982 Sega Enterprises, Inc. FROGGER is a trademark of Sega Enterprises Inc. Sears Video Arcade™ is a trademark of Sears Roebuck & Co. Atari® and Atari Video Computer System™ are trademarks of Atari, Inc.





conquering:

# TURBO

*The class act of arcade motoring*  
by Randy Palmer

**T**urbo is, to date, the ultimate video driving game. There are two models: sit down ("cockpit") and stand-up ("regular"). Although both versions are thrilling, the cockpit version is far the better of the two. The realism of its simulations are most pronounced: tremendous, often nerve-wracking sound effects provided by stereo-imaging speakers, a larger videoscreen, and a "rumble" which will shake more than your confidence, compliments of a bass-track speaker aimed directly at the player's stomach.

Why not just jump in your own car and go for a spin? For one thing, you won't be sued if you have an accident while playing *Turbo*. For another, you won't be hurt when you crash, nor will you kill anyone else on the road. *Turbo*,

you see, provides anything but a soul-soothing ride.

There are just three controls in *Turbo*, and each is essential to the successful control of the player's car:

1. A Steering Wheel, located directly in front of the driver.
2. An Accelerator, located on the far right of the floorboard.
3. A high-low Gearshift, located at the left side of the driver's seat.

You should study *Turbo* before inserting your first quarter or fifty cents. (The cockpit version generally costs more than the stand-up, but the added thrills and flashy effects are worth the extra two bits.)

Watch the attract mode to familiarize yourself with the course, and get the feel of the Wheel. Read the game's ra-

ther sketchy instructions and, if possible, watch someone else play a few games. Arcade veterans take note: *Turbo* is a sleeker, neater version of *Monaco GP*. If you are familiar with that game, this one will be that much easier.

Once you're ready to step into the driver's seat, plug in your coin, press the Start button, and steel yourself for *not* just another roadside attraction!

Before we delve into the intricacies of the eighteen terrains with which you'll be grappling, there are a few facts which apply to all the *Turbo* landscapes:

1. There is no brake! To come to a standstill, the driver must lift his or her foot completely *off* the Accelerator. The car will slow to a halt.

2. Anytime the car crashes, shift at once into low gear, floor the Accelerator,



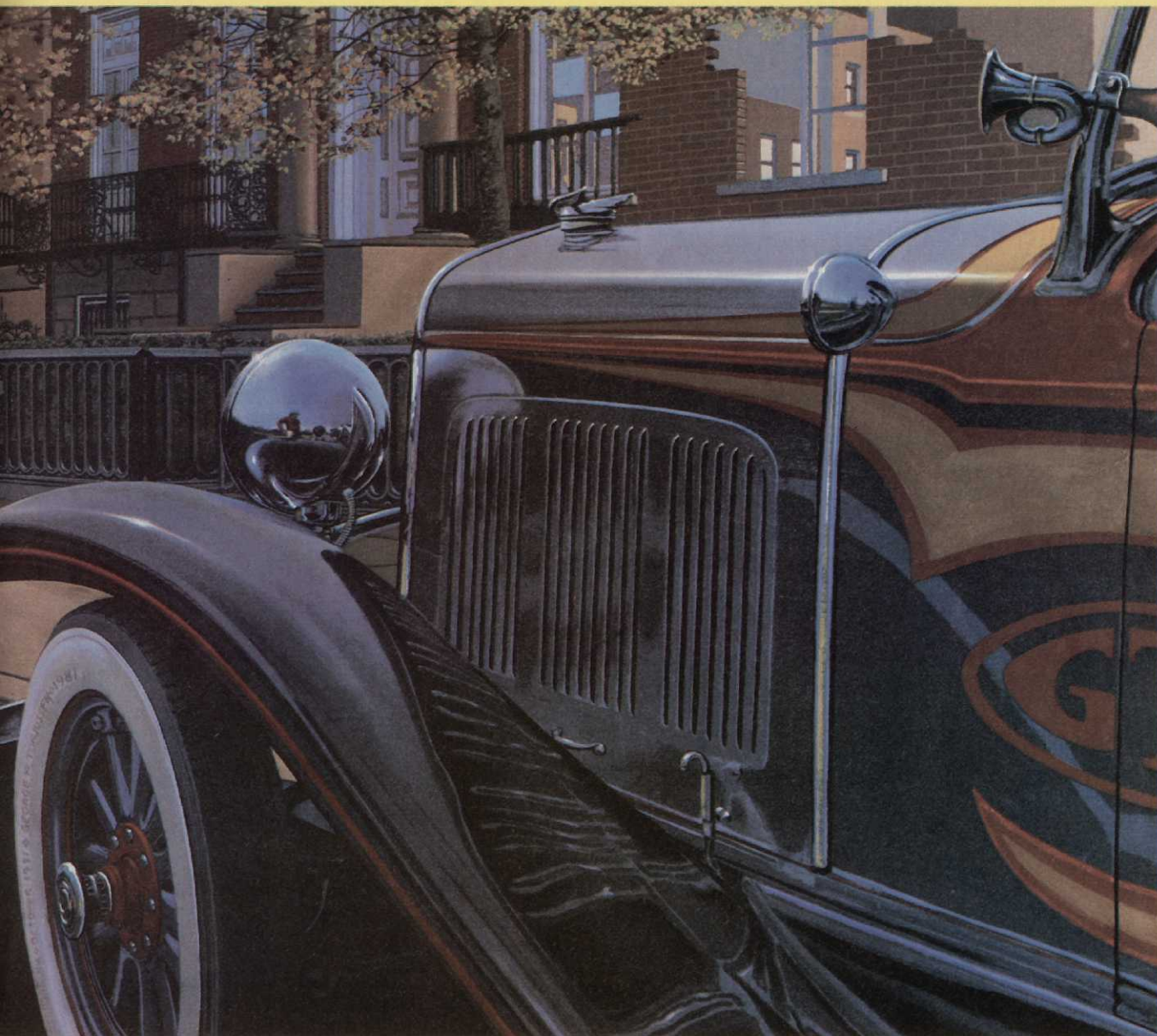

then shift into high gear after approximately two seconds — time which is spent building speed. This is the quickest way to get back into the game.

3. When restarting after a crash, spend those slow seconds on the left side of the road. You will see onrushing cars and have time to dodge them. On the right, autos barreling up the highway from behind may ram your car as it recovers slowly from paralysis.

4. The other cars in *Turbo* never slow down, and sometimes crash or simply drift across the highway dividing lines.

5. The Steering Wheel is your most important control, granting you instant relief in most emergencies — as long as you're alert enough to use it in time.

6. Keep your eyes on the road at all times. Always look ahead, toward the

screen's vanishing point, for a glimpse of what's coming your way. Stay ahead of what's behind you by driving fast.

7. Keep both hands on the Wheel for more accurate handling. When you shift gears, as during a start-up after crashing, use your left hand. As soon as you've shifted, get that hand *back* on the Wheel.

*Turbo* is not played according to a specified number of cars. It's run by a timer. The driver has *one* car which cannot be wrecked except in Extended Play. However, during that period a player can accumulate extra cars, which will be explained in more detail further along.

Those are the trappings. As for the object of *Turbo*, the driver must pass as many cars as possible while avoiding

crashes. Always drive as *fast* as possible (floor the Accelerator) except during special segments of the game, outlined a bit later.

(Note: despite tactics cited below, some players espouse a middle-of-the-road game, to avoid collisions with guardrails et al. This method is laden with drawbacks, not the least of which is that it doubles the amount of fancy footwork you must perform. Motoring along the edging regularly to the center and back allows the driver more time to study what lies ahead. Weaving left and right from the center adds needless steering. If you pay attention, you won't hit the guardrails!)

*Turbo* begins in the City setting and progresses to other stages as quickly as

*Continued on page 56*



# star words

A monthly column  
in which celebrities  
look at videogames!

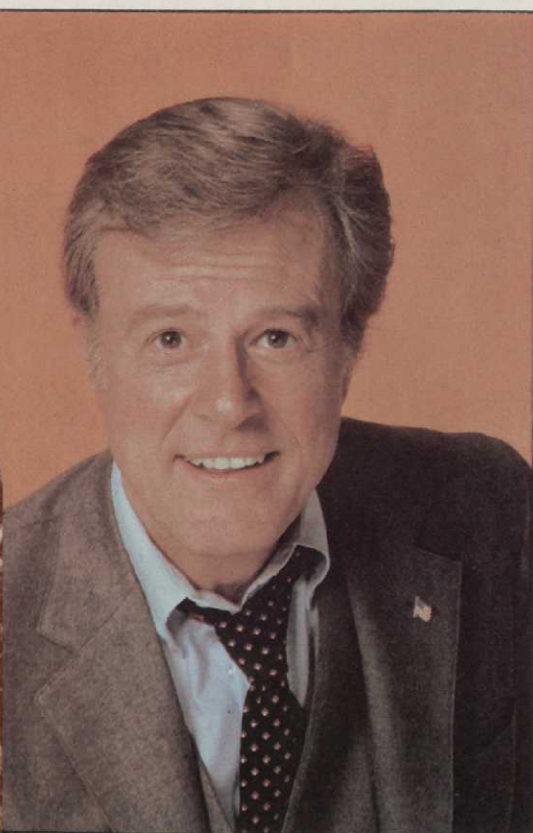
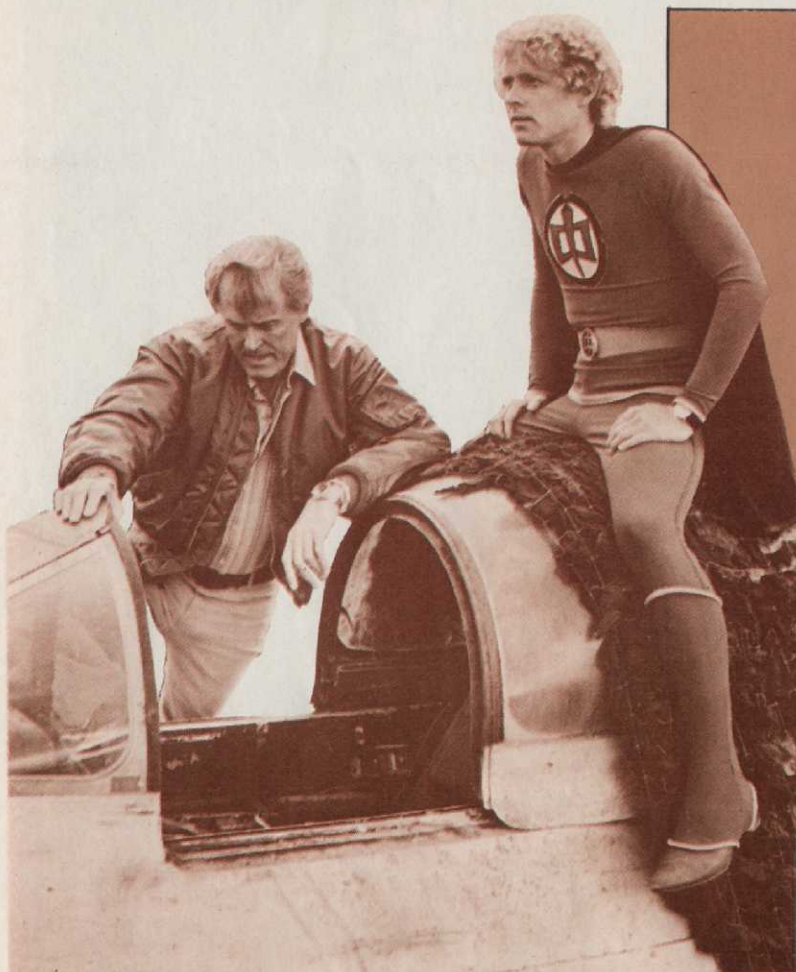

## Robert Culp

An actor speaks out about television, heroes, science fiction, and videogames.

Robert Culp doesn't find videogames extraordinary. According to the actor, he has been "living" in an exciting, multi-color fantasy universe for years.

"I was eleven years old when I discovered nirvana. Whenever I could squeeze out a dime I'd buy a comic book or Big Little Book, then sit on the floor and read it, feeling like I'd hit the jackpot. I got to travel with my men all over the universe, and I went crazy thinking about all those planets and dimensions. The stories had a lot in common with videogames, crude narratives and naive as hell. But they took hold of my sense of wonder and I became a fantasy and science nut."

Culp is about to embark on the third season of TV's science fiction hit *The Greatest American Hero*, playing a very conservative FBI agent who ferrets out spies and killers with the help of a highschool teacher who has been granted super powers by benevolent extraterrestrials.

"I'm playing Merlin to Arthur," Culp says of the part, "guiding the young king who has everything for greatness *except* experience. It's a classic theme in fantasy and folklore, and we're finally able to do it on TV because the networks — which represents the thinking of six guys, max — have come to see that science fiction is not just for the kiddies and eggheads."

Science fiction is much more than nostalgia to Culp, it's his *vis vitae*, the impelling force behind his career.

Because of his love for comic strip superheroes, Culp hurried to each new movie incarnation. His favorites were the Tarzan films, until he discovered the original novels by Edgar Rice Burroughs. He learned that the Ape Man wasn't a monosyllabic animal, that Tarzan was a cultured multilinguist.

"I went out of my mind," Culp enthuses. "The novels were about a hero who had more charisma than *any* movie or comic book character. He was

idealism personified, man triumphing to the extreme over adversity and evil. I said to myself, 'Johnny Weissmuller isn't *real* enough,' and I knew I had to fix that. I knew I had to play Tarzan in the movies."

Culp's options never allowed him to don a loincloth and head for the trees, but neither did he lose his fascination for the genre. "As I read more and more science fiction, I came to understand what it was that had hooked me as a kid, and now as an adult: it's the only field which consistently satisfies our need to *hope*. No matter how dire circumstances become, some person or being always comes down and tells us, 'Everything's gonna be okay.'"

According to the actor, that same sense of security is at the root of the videogame phenomenon. Danger and misfortune are recreated in miniature, and through our intervention is rectified. "Videogames allow us to become Superman or Flash Gordon. We're not



living *through* the exploits of a hero, we actually *become* the hero."

However, Culp feels that videogames are not without their drawbacks. "I'm not talking about whether or not they're entertaining, 'cause obviously they are. The problem is that as much as a kid can experience the *power* of a hero through videogames, there is no mode of behavior to emulate.

"When you watch something like *The Greatest American Hero* you think, 'Hey, I want to be like that dude.' But you can't fly or beat up on people who're killing porpoises, so you try to embody the principles for which the character stands. That's neat, it's good. Videogames can't give you that because there's no spirit to them. Books and movies teach us concepts of honor, morality, and ethic; *Pac-Man* doesn't do that, it's neutered."

Culp is not a videogame buff himself. He prefers the challenge of creating adventures on film rather than playing an ephemeral game, be it cards, chess, or *Turbo*. However, unlike many of his peers (see below) the actor does not view videogames and literature in an either/or light.

"Books are important for the reasons I've mentioned, but videogames are important too. It's fashionable for people to come down hard on all concepts of competition, and that's bull. It's nonsense, pure foolishness. Without competition we don't get to the stars, we perish.

"As for allegations that videogames are overly aggressive, they *do* teach you, subliminally, about the dangers of driving too fast or taking foolhardy risks. Even so, what the hell is *life* if not aggressive? It's no picnic, and the sooner kids learn that, the better they can prepare."

Yet, what is most important to Culp is something he has not heard any critics of videogaming address, and that is how none of the games teaches sexism. "The characters are abstract or androgynous, the concept of 'macho' replaced by that of 'skill.' It's an influence which is demonstrably good for young people, one which can only improve society, make it a *fairer* society."

Can videogames do all that Culp contends?

Buck Rogers drove author Ray Bradbury to his career, and Carl Sagan was pointed toward astronomy by Edgar Rice Burroughs' John Carter of Mars. George Lucas grew up on Flash

Gordon and Sinbad films, and Tarzan inspired Culp.

As the actor himself concludes, "Videogames may not have the character of these heroes, a virtue of the limitations of their computerized format; it's the price we pay for living in the latter half

of the twentieth century. But those planets and dimensions really did exist for me as a kid, and they'll exist for others only if we *encourage* flights of the imagination. Videogames are a vital part of that." ▲

## BE A GREAT AMERICAN HERO ... SORT OF.



You're probably familiar with the scenario of *The Great American Hero*: Schoolteacher Ralph Hinkley, stranded in the California desert, is visited by alien beings who give him a "supersuit," a leotard and cape which render the young man invincible.

Hinkley has no fondness for his superpowers; do you? If so, the following videogames grant players abilities beyond those of mere mortals:

*Superman*: analyzed in-depth last issue, this Atari game allows players to fly, lift great weights, and peer about with X-ray vision.

*War of Nerves*: an Odyssey game which gives you the touch of Midas, as your video figure revives paralyzed robots simply by tapping them.

*Monkeyshines*: Odyssey turns the tables allowing you to change monkeys into stone just by grabbing them.

*Quest for the Rings*: this Master Strategy game from Odyssey arms

players with Theor's Sword, which automatically slays enemies and grants the power to walk, phantom-like, off one side of the screen and onto the other.

*Adventure*: your sword's not enchanted, but you can hold monster bats in your bare hands!

*Spiderman* and *James Bond: 007* upcoming cartridges which allow you to climb walls and shoot webs or chase down spies with sophisticated gadgetry, respectively.

Not all of these cartridges will leave you "walkin' on air" as in Hinkley's theme song. However, they *will* give you a break from videogames where spaceships and futuristic hardware are your sole means of attaining the transmundane.



Yet, if you *really* want to be like Ralph Hinkley, your best bet is learn from the superhero himself. And the only way to do that is by participating in Activision's *Greatest American Hero* contest.

Entrants must play *Star Master* on its most difficult level, submitting a clear photo of their score to the game company. The highest scoring players in six age categories will be flown (by plane, not by Hinkley) to Hollywood where they will visit the set of the TV series and be introduced to stars Robert Culp and William Katt.

No guarantee that the aliens will be there with a super suit, but it sounds like fun just the same. The contest closes September 20. ▲



# star words



**Christopher Reeve**  
Star of *Superman*

"Those Pong games [sic] are just awful. Why not read a book instead? Maybe I'm a card-carrying snob, but reading lets you linger on ideas that are worthwhile, think about what's between the lines. People just die on the vine before TV's blinking light."



**Chevy Chase**  
Actor and Comedian

"Our world is in such a culture lag at the moment due to the everpresent electronic media, and I think it's terrible to see kids continually playing those stupid Ataris. I think it's sad that they don't go outside and do that same stuff with their bodies.

"But who knows? Perhaps their reflexes will be better, ultimately, their minds sharper, eyes work better. And if that's the case, we might as well put an Atari in the uterus and hope for the best."



**Mel Brooks**  
Comedian, Director and  
*Bon vivant*

"Videogames are not for us. They're here to entertain the television."

## computer eyes

You remember air traffic controllers, those people everyone was complaining about last year. How *dare* they demand more money for sitting around and watching TVs all day. Well, if you were one of those who thought they had it easy, try this game by David Mannering. At the beginner's level — where the action is so slow that nothing much happens — you're doing well if you only misplace an aircraft or two and cause less than three jetliners to crash — in just the first few minutes of play.

What's at once appealing and eerie about his game is its silence. There are no sound cues to warn you of disaster. It's all polite and real: a blip appears on the screen and you are given its speed and destination. After that, it's up to you to guide it through the crowded airspace and bring it home safely — along with twenty-five other aircraft ranging from jumbo jets to prop planes.

Communications between yourself and the aircraft are short and pithy. The

call sign of the plane is followed by a two-character code, representing fifteen possible commands which must be entered quickly for a "Roger" to be returned.

You are responsible for traffic in a 15 x 25 mile air space, from ground level to five thousand feet. Your "enemies" are the clock, fuel supply, and a sinister random event generator that keeps your radar screen busy. Each game offers a choice of five area maps, each different and posing its own special problems.

Here are some pointers not mentioned in the game instructions:

\*If aircraft enter your air space above six thousand feet, don't bring them down unless it's clear what you're going to do with them. Once they become your responsibility, your attention is monopolized.

\*Many players try to use the navigational aids for landing; *don't*. This only ties up the aid and complicates flight

patterns.

\*When a plane heads for an airport, line it up on a track which will allow you to make a direct turn at zero altitude for a landing. This may sound like Sanskrit now, but you'll thank us for it later.

Though the rules and controls are easily mastered, no two games are the same. This computer offering is pure entertainment, never dull. It does not make you want to become a toiler in the control tower vineyard.▲

*Advanced Air Traffic Controller* is produced by Creative Computing, 39 E. Hanover Avenue, Morris Plains, NJ 07950. It is available on diskette for the 32K TRS-80, the 16K Atari, and the 32K Apple II and Apple II Plus for \$19.95; on cassette for the 16K Atari and the 16K PET (Sector 3) for \$14.95.

Researched by Martin Levitan, written by Martin Levitan and Michael Alexander.

## Games for your personal computer *Advanced Air Traffic Controller*



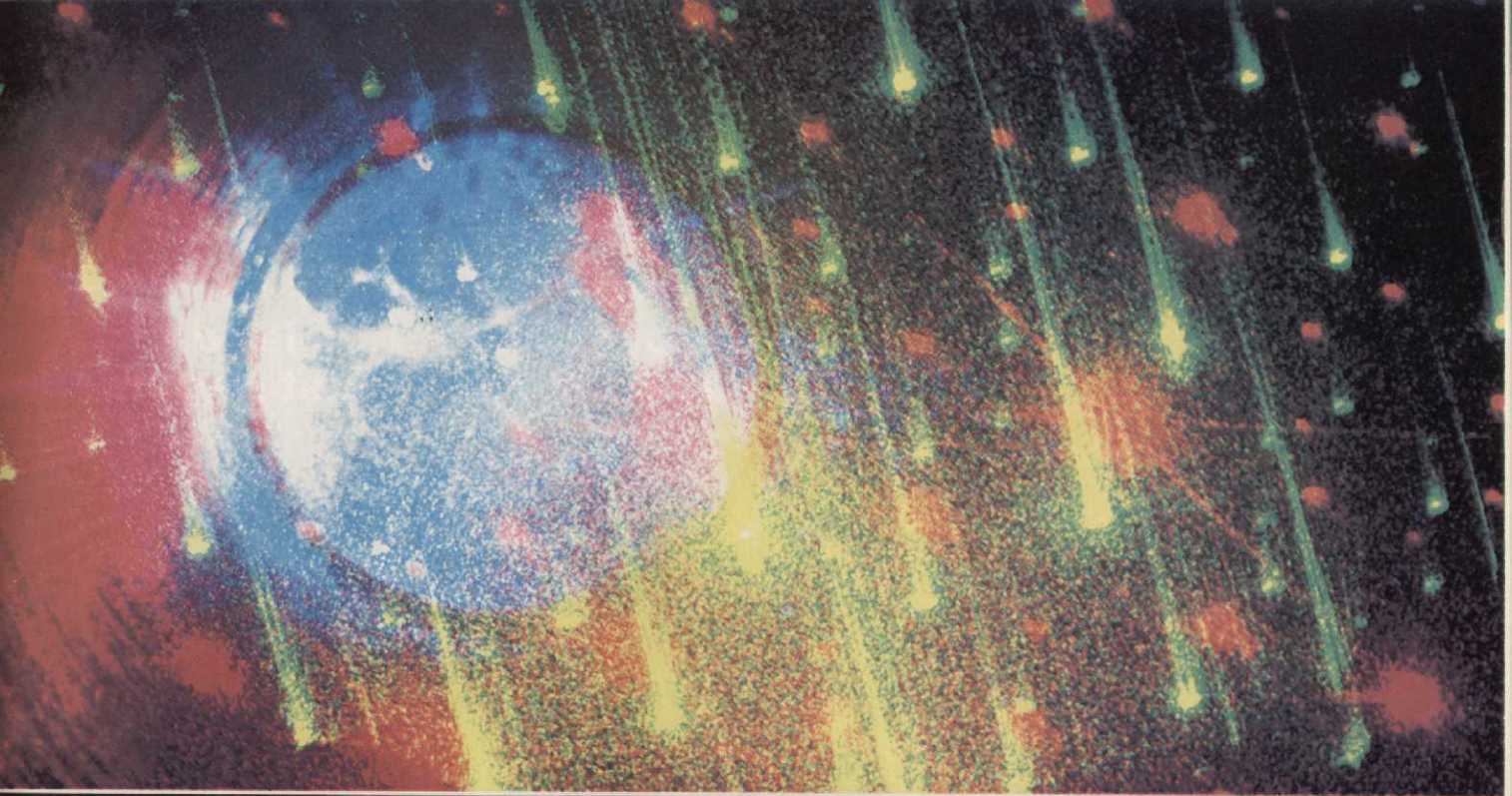

# TOMORROW ON-LINE TODAY

We're bringing the quest for adventure into cable TV subscribers' homes.

Unlimited video games mean interactive cable TV.

Educational games, adventure games, space games, fantasy games, high-speed action from the arcades, exercises in strategy, logic, cards, math and just plain fun are all available through The Games Network.

A fully interactive (two-way) television network is ready for cable TV. It is the result of a major technological breakthrough that brings you the computer TV system of tomorrow—today. It all comes through existing cable TV hookups!

---

## How The Games Network differs from Atari and Intellivision:

1. The Games Network is less expensive.
2. It has more capability with full 64K of memory. Superior graphics, unlimited games and available only through cable TV systems.
3. The Games Network home microprocessor is also a home computer, easily adapted to a variety of additional functions for both in-home and interactive cable applications. Other games' devices are single purpose and strictly limited in function.
4. Programming is not limited to games made by toymakers. The most successful and in-demand will be on-line.

---

The Games Network brings an exciting new dimension to TV. Not "someday" but now.

Welcome to the future.

## THE GAMES NETWORK™

1438 North Gower Street, Box 22  
Hollywood, California 90028  
213/464-6558

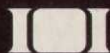

A DIVISION OF INTERNATIONAL CABLECASTING COMPANIES, INC.



**You have journeyed far...  
Your starship has landed...  
Your adventure has just begun.**



You've conquered space, blasting through the asteroid belts, annihilating every obstacle. Now you're there—the misty caverns of Zenon—ready to face the greatest challenge of all. Winged Electrosauri swoop down from above, firing deadly blasts of electromolecular energy. The dread Marsupods lie in wait. One touch of their hideous tentacles can turn you into a glowing skeleton. If you've done well at lesser games, then you *may* be ready for **SPACE CAVERN™**. But beware...

**SPACE CAVERN™** from **GAMES BY APOLLO.**  
For use with the Atari® 2600 Video Computer System™.

**GAMES BY APOLLO, INC.**

1300 E. Arapaho Road  
Richardson, Texas 75081

Atari® and Video Computer System™ are trademarks of Atari, Inc.





# meet the original...

## DONKEY KONG

*The arcade ape comes from a long line of monkeys who can't keep their hands to themselves.*

Darwin would have argued that while there are simians in our ancestry, modern-day chimps, capuchins, macaques and their ilk have no interest in humans. Who can blame them? Apart from biological incompatibility, our species are social opposites. According to ecologist Peter Veit of the American Museum of Natural History, even the mighty gorilla is a "gentle animal who roams the rain forest in peace and tranquility."

Ah, but ask videogamers about gorillas and you'll get a *different* tale. The shaggy brutes are anything *but* gentle. They don't hesitate to snatch up defenseless women, make a shambles of our proudest buildings, and pitch flam-

ing debris at anyone who tries to stop them.

Yes, *Donkey Kong* proves that there is a darker side to monkeydom than scientists have suspected. However, the world's most popular arcade game — now a Coleco home game — is not the first hint we've had of simian malevolence.

Hindustan, the world's oldest living religion, tells the ancient tale of Hanuman, the monkey general. When the wife of the demigod Rama is kidnapped, the warrior ape marches on the city where she is held. His tail is set ablaze with oily rags and — shades of *Donkey Kong* — he scoops up the woman, setting fires in his wake to



**Britain's humor magazine, *Punch*, had fun with Darwin in this issue.**

thwart pursuit.

Scheherazade tells us of "The King's Daughter and the Ape" in *The Arabian Nights Entertainment*, but that little escapade is not entirely the fault of the titular baboon: "It chanced that a great ape passed under the lattice of the princess, so she unveiled her face and signed to him with her eyes, whereupon he climbed up and night and day abode there, eating and drinking. Her father heard this and would have killed her had she not fled to Cairo with the ape." There, a butcher loyal to the king follows the princess to her palace where he uses his knife to disembowel the baboon.

Eleventh century Europe produced a folktale in which the wife of Count Gulielmus of Liguria falls in love with a monkey. The feeling is mutual and, in a jealous tantrum, the ape slays his rival. Records show that the aggressive ape theme surfaced again in 1589 in a play about Divinity who, personified as a woman, is abducted and ravaged by a gorilla, representing Hell.

A better-known incident occurred in Voltaire's *Candide*, published in 1759. Lost in the jungles of the Amazon, *Candide* stumbles upon two women be-



**An evocative sketch from the pages of *Weird Tales*, a fantasy publication which flourished in the 1930s.**



ing pursued by apes. Grabbing his musket, our hero plugs the monkeys.

Tales such as these turned many goodhearted souls against apedom, including no less a personage than one of our nation's founders. In *Notes on Virginia* Thomas Jefferson observed "the Oran-utan prefers (human) women over those of his own species." Artists such as Fremiet and Picasso didn't improve simian public relations with their myth-perpetrating "Gorilla and Woman" and "Girl with Monkey," respectively.

Inarguably, the most visible of Donkey Kong's predecessors is King Kong and his movie kin.

*King Kong*, filmed in 1933 and hor-

rendously remade in 1976, is the saga of a giant ape who tears up the streets and edifices of New York in search of his unwilling bride. Finding her with another man, he wrests the girl from bed and carries her to the top of the Empire State Building. There, Kong swats away attacking airplanes while the lady's lover races up the skyscraper to be by her side.

Like King Kong, movie apes who have had an affinity for women include *White Pongo*, *Mighty Joe Young*, and the robust simian of *Murders in the Rue Morgue*.

Nor have other media been spared

such monkey business. In comic books, Superman has frequently had to rescue Lois Lane from the clutches of Titano, the giant super-ape who scales tall buildings in a single bound. Likewise, Tarzan, the Phantom, the Flash, Conan the Barbarian and others have had run-ins with power-crazed apes.

So much for the misconception that apes are harmless. Indeed, it's clear that while scientists continue to praise the pacifism of the breed, they knew it was in the nature of the beast to be a video-game villain. After all, is there any other reason for zoologists to have given apes the scientific name of *Pongidae*? ▲



**A clutch of hostile apes: Conan pummels a simian adversary, while Superman is pestered by Titano the superape, who was irradiated while on a space flight. King Kong tears up the town in a poster from the original motion picture, while a novel based upon the adventures of a rampaging gorilla graced a British magazine of the 1930s.**

**Edgar Rice Burroughs' Tarzan of the Apes was himself raised by monkeys, but fought more than a few of them in his day.**

© Marvel Comics Group

© D.C. Comics

© ERB Inc.



## Space Battle

Continued from page 30

portionately more of your ships than it will destroy enemy vessels, use the computer *solely* as a brief, stopgap measure. For instance, if you have dramatically depleted an enemy squadron and the warning siren sounds, leave the computer to carry on while you engage a stronger unit with a fresh squadron of your own. If you're called upon to deal with yet a third group of invaders, repeat this procedure.

The alternative is to abandon one fight, recall your squadron, and engage the attackers elsewhere. Do this only if the squadron you are leaving is *farther* from your mothership than squadron to which you're moving.

Deciding which tack to use is relatively simple. Keep in mind the 3:1 ratio of losses the computer is likely to generate if left to manage a battle. If, when you turned over command, you had at least two ships to our or five of the enemy, chances are good that the computer will win the battle and leave one of your ships remaining. When that happens, make sure you recall the remnants of that squadron to the mothership: there is no point allowing it to hover in space when the ships can be used to stall an enemy closer to home.

Obviously, you should always manage the weakest squadron yourself, not necessarily the one with the fewest ships but the squadron which is most formidably outnumbered. Far better to allow the computer to deplete a squadron than to surrender one altogether.

Intellivision was kind enough to provide additional strategies in their *Space*

*Battle* instruction booklet. Most of these are primarily good, common sense suggestions, although there *is* one of questionable merit. Tactic #8 recommends that you keep the gunsight moving to prevent being hit by alien fire. This approach is no more useful than standing still: the chances of enemy lasers hitting any given spot are equally good, whether you happen to be there as result of zipping about or treading water. The advice Intellivision *should* have imparted was to move once an alien laser has been fired and you can see where it's headed.

## Comment

The problem with *Space Battle* is the problem with Intellivision itself: the control disc simply doesn't handle as precisely as a joystick or paddle. Nor is it as satisfying. Poking a small plate with your fingers doesn't provide quite the same sense of physical participation as gripping a joystick "throttle." But as spaceflight may well *be* conducted by disc in the future, that complaint is a qualified one.

In any case, the joys of the game are many, not the least of which is its two-stage radar/combat play. There is the sense of a battle *developing*, not just happening. Decisions must be made as to how you'll meet the enemy, and whether a particular fight is to be continued or abandoned. In short, there is much more to do in this game than fire artillery.

One aspect of *Space Battle* which merits mention is the facelessness of the enemy. In videogames like *Space Invaders* or *Asteroids* the opponent,

though stylized or non-living, is at least visible. In *Space Battle* we *know* there are creatures in the saucers, but they never show themselves. The imagination tends to flesh them out more than any videogame could, making the environment more realistic and the game more dimensional.

The graphics are also superb, meticulously detailed spaceships swooping and diving realistically against an atmospheric starfield. The explosions of the enemy vessels are spectacular, and your own craft's collisions with alien laserfire are quite rattling. ▲

## Supergaming

Continued from page 20

# Build your own Stroblaster

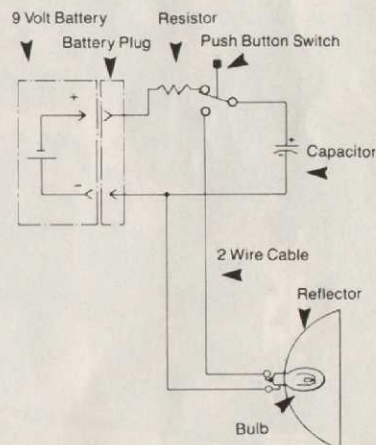

Above: the schematic for constructing a Stroblaster. As designed by Videogaming Illustrated electrical wizard Lawrence J. Levine, this unit will allow you to add off-screen flares to your videogame play. Below: The Stroblaster itself. Next issue, the author will show you how to hook the Stroblaster to your joystick. Without impairing play, you will be able to trigger a flash every time you depress your action button. ▲

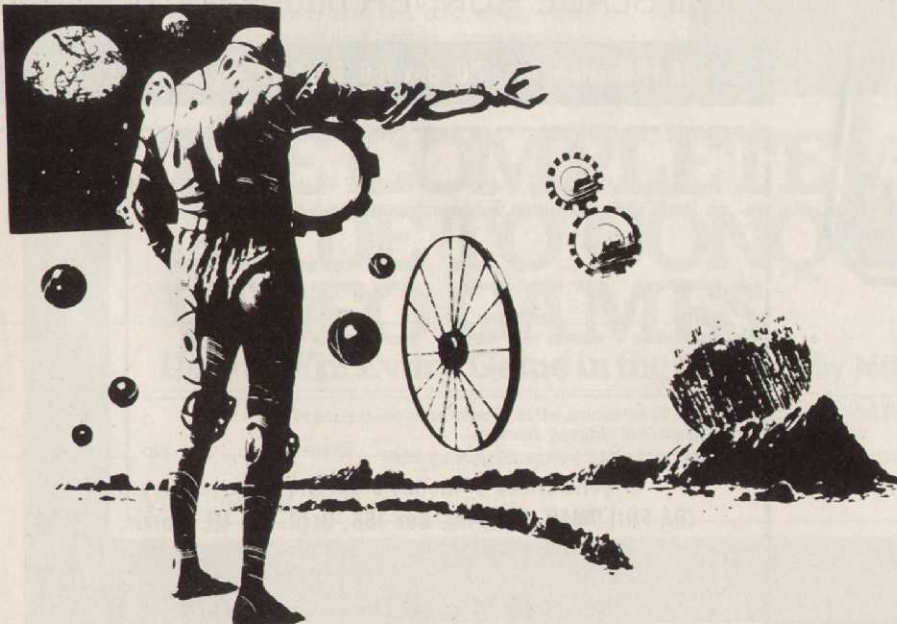



Like Being On **The Movie Set!**

# BLADE RUNNER™

OFFICIAL SOUVENIR MAGAZINE



Here is the Collector's Edition you will treasure always—authentic, complete, the studio-authorized "inside" look at the sensational film everyone's talking about!

Many exclusive color photos give you the whole, exciting BLADE RUNNER picture-story so you can re-live your favorite moments from the film.

This big publication also takes you behind the scenes—reveals everything you want to know about how BLADE RUNNER was made—from special effects secrets to model miniatures, vehicles, costumes, production paintings, blueprints, storyboards and much more.

## Plus you'll enjoy the highlights of 14 Exclusive Interviews

Listen in on fascinating conversations with Harrison Ford, Director Ridley Scott, Special Effects Director Doug Trumbull, Production Artist Syd Mead, Author Philip K. Dick. Plus many other cast and crew members!

It's all here in this big, beautiful document of the film epic—the only official BLADE RUNNER publication of its kind!

**IRA FRIEDMAN, Inc., P.O. Box 166, Dept. J2, Mt. Morris, IL 61054**

**Yes!** Send me the official BLADE RUNNER Souvenir Magazine at \$2.95 each (plus \$.75 each postage & handling).

(Please Print Clearly)

Name \_\_\_\_\_

Address \_\_\_\_\_

City \_\_\_\_\_ State \_\_\_\_\_ Zip \_\_\_\_\_

Send check or money order (no cash, please) to:

**IRA FRIEDMAN, Inc., P.O. Box 166, Dept. J2, Mt. Morris, IL 61054**

Canada add \$1, foreign add \$2 - U.S. funds only

Allow 3-6 weeks delivery

**MONEY BACK GUARANTEE**

If you don't want to cut this coupon, send order on a separate piece of paper

TM © 1982 The Blade Runner Partnership © 1982 Ira Friedman, Inc.

- **Over 140 Photos & Illustrations** Many in Full Color
- **68 Big Pages**
- **Color Centerfold**
- **Quality Paper**

**MAIL COUPON TODAY!** ▶



# GET THE VIDEO GAMEBOOK THAT ZAPS ALL THE OTHERS.

Pow! Ka-zaz! Ka-boom! The video game craze has conquered the land.

And *The Complete Guide to Conquering Video Games* will blitz the competition because it's the best—and the best is always worth waiting for!

No other gamebook has—

- *More than 250 games*—home, computer and arcade—including the very newest on the horizon
- *A rating system* to the games that give the most for the money
- *Simple how-to instructions* to turn beginners into winners
- *Super-sophisticated strategies* to make experts more skillful
- *The exclusive VideoGraph Conquering System* to chart progress
- *Video Originals*—how to play even more games on existing cassettes
- *An Alternate Selection of the Literary Guild*—*the only videogame book being offered by a major bookclub!*

Jeff Rovin, former video columnist of *Omni* magazine, and now editor of *Videogaming Illustrated* magazine, gives confirmed addicts what they want and what they need.

The battle of the video gamebooks is over. *The Complete Guide To Conquering Video Games* is bigger and better, more exciting and more thorough than any other gamebook in the universe.

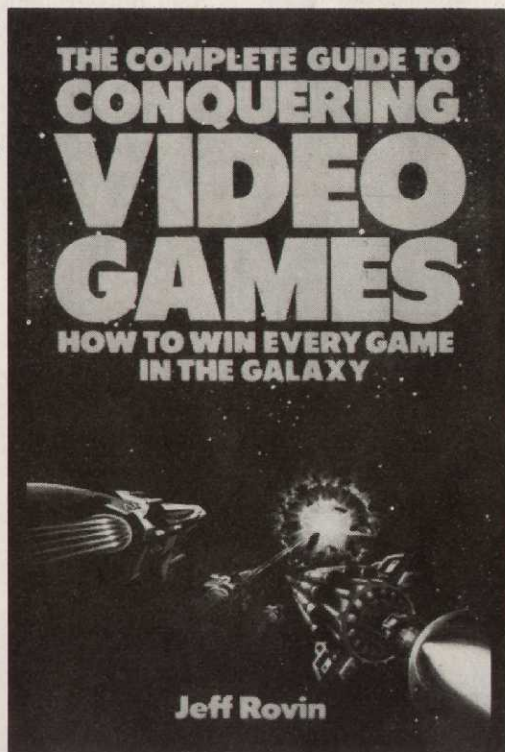

416 pages/5 1/2" x 8 1/4" paperback

## THE COMPLETE GUIDE TO CONQUERING VIDEO GAMES

**How to Win Every Game in the Galaxy** by Jeff Rovin

To order, please send checks in the amount of \$8.95 plus \$1.55 postage and handling for each copy ordered, payable to *Videogaming Illustrated* to:

Videogaming Illustrated, 32 Oak Ridge Road, Bethel, Connecticut 06801

MACMILLAN



## Turbo

Continued from page 45

the driver makes it happen (ie, if you motor slowly through the City, it will take longer to reach the Hill).

### The City

After pressing the Start button, a stop light will flash red three times before it turns green.

You should be in Low Gear with the Accelerator already floored *before* the light goes green. This will ensure a quick start. Four other cars will move ahead of you, but don't fret — you'll pass them quickly enough. Wait about two seconds then shift into high gear.

Pass cars which are cruising in your own lane by *jerking* the Wheel, which will swiftly move the car into the left lane. Don't *ease* the car over, you'll be traveling too fast; by the same token, don't crash into the roadside, which is outlined in red and white stripes.

Once in the left lane, the immediate danger is oncoming cars.



**Ample thrills and breathtaking visuals for a quarter are the secret of Turbo's success as a standup attraction.**

### The Hill

Terrains change abruptly in *Turbo*. The driver swiftly leaves the City behind and fast approaches the Hill (or Dip, as some call it). Maneuvering the car over the Hill is initially one of the most difficult tricks in *Turbo*, though as you play the game more often it becomes one of the easier challenges.

The trick to avoiding crashes on the Hill is to decelerate the *instant* you see a car approaching, flooring the pedal as soon as there's an opening to pass to the left.

Please note that you cannot see the downside of the Hill. There will be oncoming cars in the left lane as well as cars in your own lane which won't be going as fast as the driver's car. In addition, the oncoming cars in the left lane may pass *each other* by swinging into your lane as they approach the Hill from the opposite side.

Hasty slowing and speeding *when appropriate* is the key here — and the *only* good strategy. Taking the Hill at a constant, slower-than-normal speed will cause delays in completing the course; excessive speed will invite accidents.

### The Highway

Compared to other terrains in *Turbo*, this Highway and the one which follows provide respites from the tortuous Hills, Tunnels, and Bridges.

Speed down the Highways as fast as possible. If your car accidentally runs onto the shoulder, you'll hear a rough scraping sound. Get back on track and quickly as possible: riding the shoulder slows your speed and can result in an accident.

### The Bridge

There are two Bridges in *Turbo*. Both squeeze the roadways into thin lanes, thus restricting the passing capabilities of your car. Even so, passing on a Bridge calls for the same strategy as used on the Highways — the difference being that *very* short twists of the Wheel will be required to survive.

### The Curve

There are two Curves, the first heading toward a range of mountains, the second away from them. Both Curves come suddenly after crossing the Bridge.

Decrease your speed slightly on the Curve. Don't worry if you aren't able to pass many cars; the displaced vanishing point makes it difficult to see oncoming

vehicles. Fortunately, the Curves are of relatively brief duration. It's best to play it cautious here and *only* here; a moderate pace will avoid crashes and get you through faster than speeding along and piling into scenery or other cars which come from around the corner.

### The Cylinder

After each Curve, the car will suddenly whip around a road nestled between a towering cylindrical object and a large body of water. During this Cylinder passage, the player must pass two cars. One of the cars must be passed on the inside — that is, closest to the cylinder — the other negotiated by snuggling up to the markers beside the guardrail.

Because the road is narrow surrounding the Cylinder, it takes care and concentration to squeeze past the two cars. Luckily, your job is made easy by the fact that this is a one-way road.

### The Ambulance

Leaving the Cylinder, the driver will see a yellow flag waving at the top of the screen, warning that an Ambulance is approaching from behind. A siren will sound; the driver *must* pull over to the right side of the road.

The sooner you release the Accelerator, the quicker the Ambulance will pass. Don't try to keep pace with the Ambulance; it won't move ahead until you slow. Shift into low gear; the instant the Ambulance is in front of you, floor the Accelerator and shift into high.

### The Tunnel

As the driver approaches the Tunnel, it will appear as a small black splotch on the horizon. A second later it will loom large and the car will zoom into blackness. Here, the red-white roadside shoulders turn lime-green. Tiny "windows" flicker past, and you'll *feel* the vibrations of the turbo engine.

Because of the extreme darkness of the Tunnel, the other cars are difficult to see, dark-blue in color as if reflected by moonlight. These cars will be barreling recklessly down the left lane, the right lane cars moving slower than your own. Thus, it's best to keep your eyes on the critical left side, watching your own lane with peripheral vision. Pass when the left is clear, speeding quickly to the maximum; decelerate when it is not.

### The Ice

Prepare for a spin-out on the icy road which follows! Brace yourself by wrap-



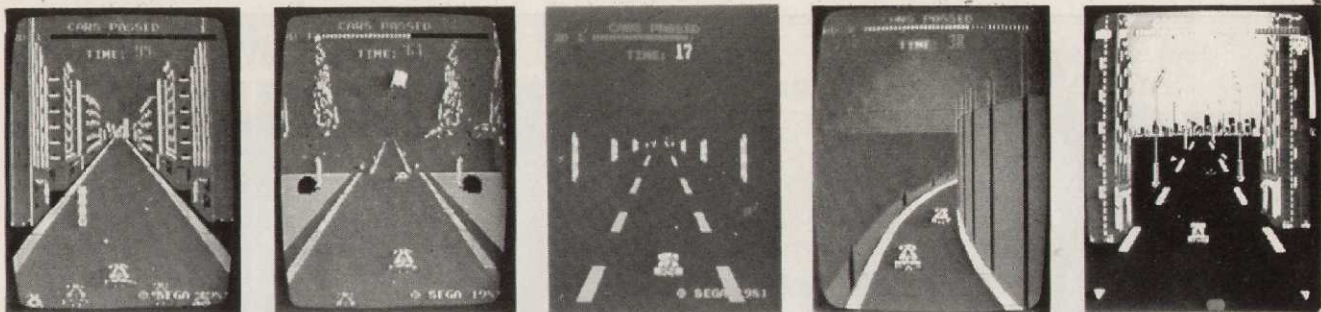

**Five of the brilliantly rendered vistas seen in *Turbo: the City, the Hill, the Tunnel, the Cylinder, and the Second City at sunset.***

ping both hands tightly around the Wheel.

What makes the Ice dangerous is *not* speed, but the way you steer. Don't jerk the Wheel as you would during normal Highway driving; if you do, your maneuver will be exaggerated and you'll crash into one of the many trees which surround this icy stretch.

Because there are far fewer cars on the road during this section of *Turbo*, you can turn the Wheel gradually when passing. As long as you ease around the other cars, top speed can be maintained with facility.

If you *do* spin-out, take it slow when starting back up again. Shifting into high too soon will cause your wheels to spin as in actual winter conditions, and you'll waste precious seconds.

### The Short Highway

*Turbo* provides the driver with a breather as she or he enters the second stretch of straight roadway, the Short Highway. All of the strategies employed in driving the previous Highway, apply here.

Unfortunately, the Short Highway is just that; in fact, it's a bit *too* short. Before you know it you'll find yourself in the second *Turbo* Tunnel.

At this point, the driver faces new versions of terrain already covered. After the second Tunnel is another stretch of regular Highway (this one flanked by light poles), a Curve, a second Cylinder followed by another Short Highway, one more Hill, then the second Bridge. The strategies for each remain the same.

### The Second City

The drive should slow down upon entering this course, as on-coming vehicles will be colored dark-blue against the black asphalt of the city's streets. Again, pass as many cars as possible. This is especially important here because as you enter the Second City you are also entering *Turbo's* second phase, where you can win "spare cars."

### Puddles

On occasion the car will "hydro-plane" across small, light-blue Puddles located in various portions of the road. Puddles pose little threat to good drivers. Even though you temporarily lose control, if you don't overcompensate — just steer gently into the spin — the car will soon be back on dry asphalt. The danger in fighting the slick is giving *too* much power to the runaway car, causing it to swivel and crash.

### Winning Extended Play and Spare Cars

In order to win Extended Play, a driver must pass at least thirty cars during regular play. Each car passed beyond the required amount adds more time to the game. A horizontal graph at the top of

the screen indicates how many drivers you've left in your dust.

A player can also be awarded Spare Cars once Extended Play is entered. A total of four Spares is the limit any player can accumulate.

Spare Cars are needed to continue playing *Turbo* only after the driver's original car blows up, which can happen only during Extended Play. If the driver has been awarded a Spare, play continues and the entire sequence of terrains will repeat as often as necessary.

At the game's end, the player who beats any of the five scores shown on the "Best Five" board at the left of the screen can "steer in" his or her initials. Follow these guidelines, and you'll make automotive history before you know it!

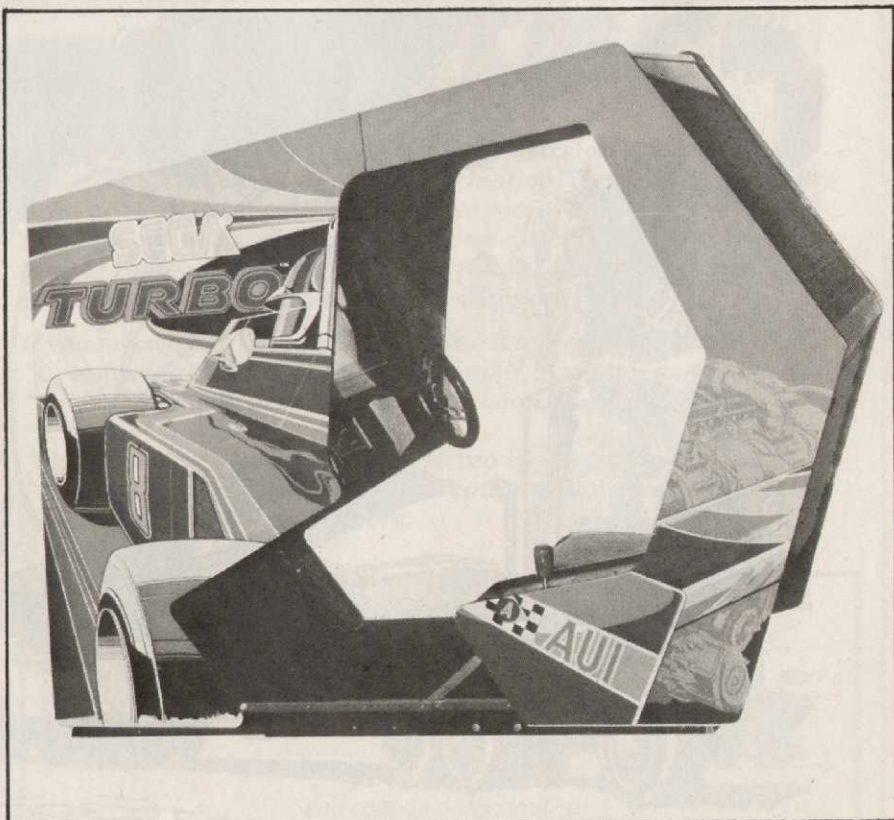

**The Turbo experience which will cost you fifty cents and is worth every penny.**



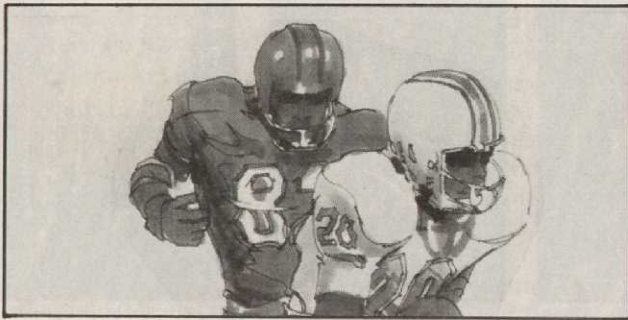

**VIP**

*Continued from page 15*

**Q:** Speaking of your work, you've experienced the pressure of playing in big games. What advice can you offer videogamers about dealing with stress?

**A:** I don't think they're the same kind of pressure. What I live with in football is like the pressure people feel every day at their own work. They have to meet goals, produce for the people above them; I have to perform well enough to keep Tom Landry happy so I can continue to play with the Cowboys. The kids here don't have that kind of responsibility, they play mostly out of enjoyment. There *are* kids who get carried away, just like in anything else. You can see the competitor in them while they're playing, and by the third quarter — twenty-five cents, I mean; let's not confuse our sports here — by then you can see they're really into the game, punching the machine if they don't win and stuff like that. I don't think that's bad. It's competitiveness which can't be released at school or work so they come to the store.

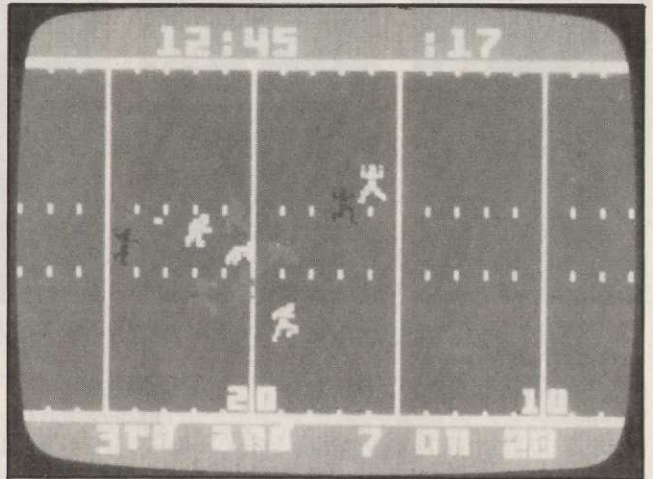

**The Intellivision football screen rated by Saldi as "the best."**

**Q:** Do you think that having an outlet like videogames can lead to a better attitude toward school?

**A:** Absolutely, because videogames teach you a very important quality: preparation. No one likes to fail, whether it's at school or recreation. Here they learn that doing well means being prepared. That's got to rub off in other areas.

**Q:** Are you planning to open other arcades?

**A:** I hope to. This is a sound business and it's also very rewarding, like running a camp year-round. As long as I can generate the kind of atmosphere that I can be proud of, that this *city* can be proud of, I'll put a Cowboy Jay's wherever they let me!



**" JUST WHAT AREA OF U.S. ELECTRONICS HAS OUR INTELLIGENCE NETWORK TAPPED INTO? "**



**Do you find soap operas a grind?**



**Does modern literature shock you?**



**Has life lost its bite?**



**Put an end to the ordinary! Pick up Videogaming Illustrated for news and views about the most exciting pastime of them all!**

Be here next issue where you'll —

- \*Experience the joys and terror of Videodrome
- \*Journey through the universe which lies beyond Zaxxon
- \*Learn how Atari almost wasn't
- \*Meet an Oscar winning actor who is videogaming's staunchest ally

**October 19**

Or you can have every issue of Videogaming Illustrated sent to your home simply by filling out the convenient coupon at right.

**DON'T DELAY! SUBSCRIBE TODAY!**

- Six issues for \$15 (\$19 Canada and elsewhere)
- Twelve issues for \$28 (\$36 Canada and elsewhere)

Name \_\_\_\_\_

Address \_\_\_\_\_

City \_\_\_\_\_ State \_\_\_\_\_ Zip \_\_\_\_\_

Send coupon or facsimile to  
Videogaming Illustrated,  
32 Oak Ridge Road, Bethel, CT 06801

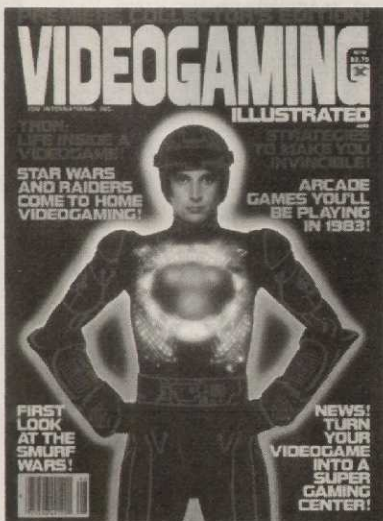

**Think of it as an extra fire button.**

That's how important Videogaming Illustrated is to your game-play. Each issue arms you with information to enhance your enjoyment of electronic pastimes. Whether you're looking for game strategies or news, analyses of hardware or reviews of software, a look at computer and game-related movies or incisive interviews, you'll find it all in Videogaming Illustrated.

If you missed our first issue, you missed our coverage of:

- \*Conquering Laser Blast, UFO, Defender, Stargate, and Superman.
- \*An in-depth look at the new Coleco Vision.
- \*A peek at Odyssey<sup>2</sup>.
- \*How to wire your videogame to stereo speakers.
- \*A behind-the-scenes look at the creation of the special effects in Tron — and much, much more.

A few issues of our Collector's Edition first issue remain. To get your copy, or to order one for a friend, simply fill out the coupon below, enclosing a check or money order for \$3.50. Mail to Videogaming Back Issues, 32 Oak Ridge Road, Bethel, CT, 06801. Your copy will be sent at once in a sturdy protective envelope.

Name \_\_\_\_\_

Address \_\_\_\_\_

City \_\_\_\_\_ State \_\_\_\_\_ Zip \_\_\_\_\_

Send coupon or facsimile to  
Videogaming Illustrated,  
32 Oak Ridge Road, Bethel, CT 06801



Continued from page 10

## THE ILIAD OF ODYSSEY

The people at Odyssey have long-complained that while Atari and Intellivision are showered with acclaim for their gameplay and graphics, Odyssey gets nothing — not even *bad* press.

Well, the NBC of videogames is finally getting the recognition it deserves. Odyssey is the official videogame of the 1982 World's Fair in Knoxville, TN.

The Odyssey games are located in a twenty-four foot area of the America's Electrical Energy Pavilion. Over forty different titles are set up at the fifteen videogame stations therein.

In deference to Atari and the others, it's only fair to point out that Odyssey is based in Knoxville. On the other hand, no other videogame manufacturer offers the same balanced blend of action, educational, and juvenile cartridges.

Regardless of the local pride fair officials may have felt in bestowing the honor on Odyssey, the overwhelming popularity of the exhibit has more than justified their decision.



## THE FIRST HOME VIDEOGAME SEQUEL!

"Lay her i' the earth; And from her fair and unpolluted flesh May violets spring!"

Shakespeare may not have had *K.C. Munchkin* in mind when he penned his hopeful verse, but the words *do* apply. Like the phoenix, *K.C.* is rising from oblivion, sweeter and more colorful than ever.

In October, Odyssey will release *K.C.'s Crazy Chase*, the sequel to its court-enjoined muncher. There are changes in the maze and in the gameplay so that *Pac-Man* doesn't haul

Odyssey back into litigation. However, fans of the old *K.C.* will find the gobble as convivial and beleaguered as ever.

The revamped *K.C.* now spins cartwheels through a labyrinth, its goal being to catch a fleeing, segmented caterpillar. *K.C.* must elude obstacles such as trees in an effort to eat every segment of the insect but its head, which is lethal. Once the caterpillar has become ingested, the game regenerates and the pace quickens. As in *K.C. Munchkin*, the mazes are programmable.

This Fall will also see the debut of the Odyssey castle-smashing game *Smither-eens*, along with four other



cartridges. Already in the marketplace are the new *Type & Tell*, the spelling bee game *S.I.D. (Spelling Interactive Dialogue)*, and *N.E.D. (Number Education Dialogue)*, all of them cartridges for Odyssey's Voice module.

## MISSING LINK?

In our new section entitled, "Meet the Original ...", we show you the cultural ancestors of the world's most popular videogames.

There's one game you *won't* be seeing in this regular feature: *Pac-Man*. We aren't excluding the fellow because we don't love him, it's simply a case of over-exposure.

Having said that, however, we couldn't resist this little item.

In 1976, renowned cartoonist/author Shel Silverstein published a wonderful children's book entitled *The Missing Piece*.

This book is the annals of a circle who suddenly realizes that there's a wedge missing from its body, a circumstance which it finds most unsettling. The circle searches for the pie-shaped fragment, rolling through a series of adventures along the way.

The search is fruitless,

although the circle learns to be happy in other ways than completeness.

The circle has had other published adventures, but that is for another time. What's important is Silverstein's drawings.

Remind you of anyone?

In case you fail to see the resemblance, we've printed the circle alongside another figure prominent in the media.

The circle could not be reached for comment.

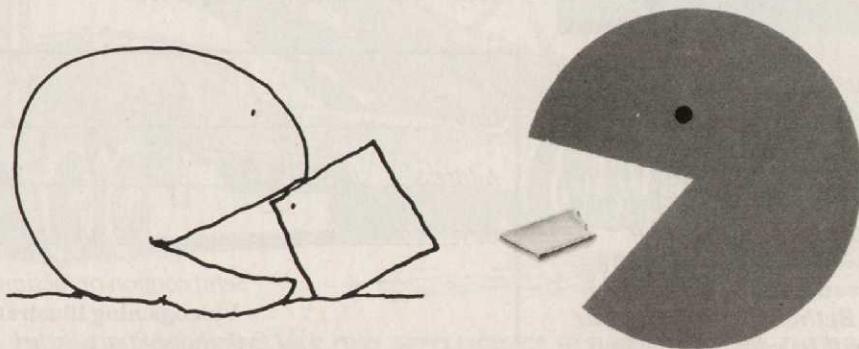

Long lost cousins? Silverstein's "It" and Pac-Man.



## ON ANOTHER FRONT

Elsewhere, we've noted the intent of Apollo to produce games for Intellivision; last issue it was reported that Coleco is already into production on their Intellivision-compatible cartridges.

Now, there's a third manufacturer expanding the library of games for your master component: none other than Activision.

In November, the company will release *Stampede* and its brilliant new *Pitfall* in the Intellivision format, expanding the graphics and gameplay beyond what is possible using the Atari console. Two additional cartridges will be shipped early

in 1983, with others coming throughout the year.

During its three-year history, Activision has manufactured cartridges only for the Atari unit, and with good reason: nearly eighty percent of all the consoles

purchased to date have been from Atari. Activision president Jim Levy says the reason for diversification is simple. "We feel that Mattel's Intellivision, with more than one million units in use, is a strong force in the

marketplace." He adds that his company's wealth of design and marketing talent, "will enable Activision to bring its high quality standards to this exciting new line of games."

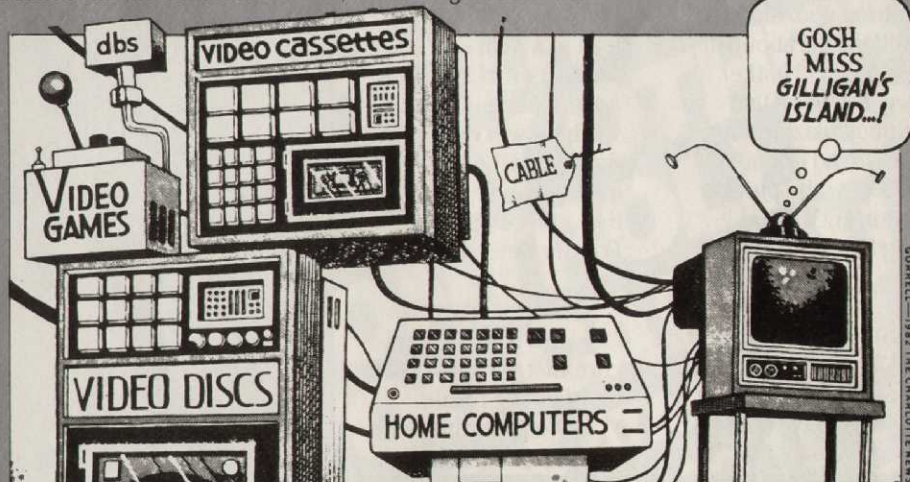

In the 1960's: THE SILENT SPRING, in the 1970's: FUTURE SHOCK:

# NOW: THE HIGH ROAD

## Ben Bova

**"We are in a new space race today, and most Americans are not even aware of it."**

*The race is not for national glory or political prestige. It is a race against time and against humankind's ancient enemies: hunger, poverty, war, and death,"* says Ben Bova, Editorial Director of Omni. **THE HIGH ROAD** is Ben Bova's plan of action for building a world of abundance by using the enormous wealth that has already been discovered in space. **THE HIGH ROAD** leads to prosperity — without war.

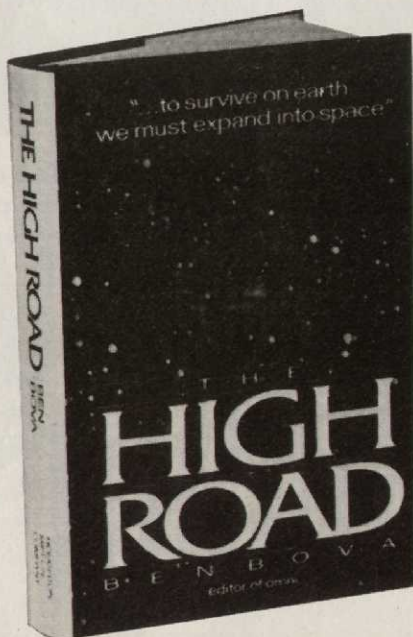

Dept. HR  
Houghton Mifflin  
2 Park St  
Boston, Ma 02108

Yes, Please rush me a copy of **THE HIGH ROAD**, by Omni editor Ben Bova. I enclose my payment for \$11.95 plus \$1.50 for postage. If I am not delighted, I may return the book within 10 days and my money will be refunded at once.

Name \_\_\_\_\_  
Address \_\_\_\_\_  
City \_\_\_\_\_ State \_\_\_\_\_ Zip \_\_\_\_\_  
 Check or money order enclosed  
 VISA (BankAmericard)  
 Master Charge  
Exp. Date \_\_\_\_\_  
Account # \_\_\_\_\_  
Interbank # \_\_\_\_\_ (Master Charge Only)  
Signature \_\_\_\_\_

Print clearly please. Allow 4-6 weeks for delivery.



# eye on

## THE GLITCHERY

Last issue, Activision's Jim Levy shuddered at the thought of *Pac-Man* ice cube trays; this issue, Robert Culp lam-basts *Pac-Man* day.

Ever wonder what the rotund gourmand himself thinks about all this celebrity? Neither did we. But the Atari fan club magazine *Atari Age* was kind enough to interview the plucky predator, and the following facts came to light:

*Pac-Man's* favorite baseball player is Willie Maze.

The self-described "mellow yellow fellow" started in show busi-

ness by playing follow-the-bouncing-ball parts in musical movies. He was also one of the Scrubbing Bubbles in the famous TV commercial.

Prior to going pro, *Pac-Man* played the lead in a high school production of *Man of La Muncher*.

There was no indication as to whether the golden gobbler is getting a piece of all the *Pac-Man* merchandising.

Our own efforts to talk with the video epicure met with less than satisfactory results.

As *Pac-Man* himself would say ... dot's life!

## IN THIS CORNER ...

It seems that the videogame industry is never without a few dozen lawsuits. Bouts between the home game manufacturers are rare, legal disputes arising primarily between the holders of hot arcade properties and those who are said to have ripped-off those properties.

But there is a hefty battle shaping up between Astrocade and Atari. The vi-

deogame giant is being sued for allegedly infringing patents held by Astrocade, claims which the latter has also leveled against Commodore Computers.

The suit centers around a process known as "bit mapping," which determines the way the game image looks on the videoscreen. An Astrocade spokesperson says that damages being sought will most likely be "in the millions."

## THE ROBERT REDFORD VIDEOGAME

Don't laugh, we may yet see one as more and more motion picture studios enter the videogaming ring.

First there was Warner Communications, which bought Atari and made it part of the family which owns Warner Brothers. Elsewhere in this column you've read about the new CBS/Bally venture. Now, gird yourself for Universal Pictures and 20th Century Fox to get into the act.

Nor do the convolutions end with simple corporate purchases or the act of setting up a videogame division. Atari recently announced an agreement with Lucasfilms to use the movie company's special effects expertise to create dazzling illusions at arcades around the country.

Is this a sign of great innovations to come, or a slide toward "sameness" in the arts? Watch this column for future double bills.

## PSYCHOLOGICAL WARFARE

It was probably just coincidence, but while one Astrocade publicist was busy announcing the law-

suit, another was providing *Videogaming Illustrated* with details about their new *Conan* videogame. Who would dare challenge a company with Arnold Schwarzenegger on their side?

As we reported last issue, *Conan* is based upon the popular literary character and sends videogamers into dungeons, allows them to cast magic spells, pits them against wizards and monsters, and offers other role-playing motifs.

Ray George, Astrocade's marketing vice president, remarked that because of its many challenges, "Conan will actually speed up your thinking, improve your ability to solve puzzles and exercise your imagination. I predict it will be the most popular videogame cartridge ever. It may even out-sell Rubik's Cube."

If it doesn't, Astrocade can always use what's left of their Conan license to send the Barbarian against Atari. ▲

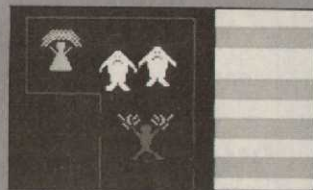

# facetiae

The column which dares you to identify five popular home videogames based on the following verse.

I  
Little mascots stunning folks,  
Roam straight or at an angle.  
They love to give each other pokes  
Or find a boss to strangle.

II  
Charging swiftly in pursuit  
You bump or tie or pass;  
Your objects, colored and hirsute,  
Are awfully fond of grass.

III  
*Pac-Man* hasn't any thrill  
This gasser hasn't got.  
The maze symmetrical, but still  
The goal is eat-the-dot.

IV  
Rolling in, these sitting ducks  
Start quacking du projectiles.  
Maneuver while you blast the clucks  
or brain 'em when your wreck falls.

V  
Bewitched, bewildered, there you are  
Beset by ships galore.  
Ice them, and your space radar  
Tells you whence come more.

V: Space Battle  
III: Dodge 'em, IV: Laser Blast,  
I: War of Nerves, II: Stampede

Answers:





# THE ZIRCON VIDEO COMMAND JOYSTICK OUTPERFORMS EVERY OTHER CONTROLLER YOU CAN BUY

FOR THE ATARI VCS,  
ATARI 400/800  
& VIC-20 COMPUTERS  
Works Like A Jet Fighter Joystick  
Rugged, Reliable & Lightweight  
Fast, Positive Response  
Comfortable To Hold



**JET SPEED CONTROLS**  
Push Down Instant Fire  
Left & Right Movements  
Forward & Back Movements  
Forward & Back 45° Angles

THE J3021 VIDEO COMMAND STICK IS AVAILABLE AT  
MAJOR STORES WHERE VIDEO GAMES ARE SOLD.

**Zircon International, Inc.**  
475 Vandell Way, Campbell, CA 95008  
408/866-4500



\*ATARI VCS, ATARI 400/800 & VIC-20 are trademarks of Atari, Inc. & Commodore International, respectively.



# print out

If you've been spending all your time (and money) at the local videostore, take a respite and visit your neighborhood bookshop. There are a number of fascinating new works on the market — to which we'll turn after a few obligatory paragraphs on the swelling list of books about videogames.

For five years — roughly half the life of the videogame medium — there were only two books on the subject: *Videogames, a Complete Guide* by Len Buckwalter (Tempo, \$1.95) and *The Complete Book of Videogames* by the Editors of Consumer Guide (Warner Books, \$1.75). Both volumes explained how videogames work and evaluated the systems which were available in 1977.

Cube-itis infected the nation in 1981, publishers selling over ten million copies of books about how to solve Rubik's Cube and its various knockoffs. The phenomenal success of these books convinced publishers that videogames would make an equally commercial topic for "How to Win ..." volumes, and the deluge began.

The first book of the craze was an innocuous little paperback entitled *How to Win at Video Games* by Ray Giguette (The Martin Press, \$2.50). This collection of interviews conducted with arcadists was quickly overshadowed by Tom Hirschfeld's *How to Master the Video Games* (Bantam, \$2.95). Martin Press could not distribute books as effectively as Bantam, the world's largest paperback house. Thus, Hirschfeld's compilation was everywhere and effectively

had the field to itself, both factors helping to make it a bestseller.

Next on the shelves — and bestseller lists — was *Mastering Pac-Man* by Ken Uston (Signet, \$1.95.) The Uston book is a good one if you overlook the sleep-inducing layout, black and white and redundant. The editors at Consumer Guide rectified those flaws with their *How to Win at Pac-Man* (Pocket Books, \$2.25) which likewise best-sold, its text informative while its full-color illustrations and jazzy design came close to matching the graphic excitement of videogaming.

Those books began and ended the meteoric era of bestselling videogame books. Nor is that surprising: virtually everything else on the market is dross.

For completists or masochists, there are presently nineteen other opera on the market. Among them:

- *Scoring Big at Pac-Man* (Warner, \$1.25) and *The Winner's Book of Video Games* (Warner, \$5.95), easily among the worst of the lot. Both are by Craig Kubey, who cares enough about his friends and family to bore us with their videogaming exploits, and whose overly-glib style (re *Space Invaders*: "Get them to join the church. Hope one of them will ask the daughter to the prom.") makes the rest of his writing unbearable.

- *How to Beat the Video Games* by Michael Blanchet (Fireside, \$3.95), a useful arcade game strategy guide, but painfully illiterate.

- *Video Invaders* by Steve Bloom (Arco, \$5.95), an excellent biography of Mr. Bloom, whose life and loves intrude whenever this survey of the games and industry threatens to become interesting.

- There are also: *Pac-Mania* (Pinnacle, \$1.95), featuring cartoons of Pak's Peak, Pac-tical jokes, et al; *Defender and Ms. Pac-man* (Greenwich House, \$2.98); *Secrets of the Video Game Super Stars* (Avon, \$2.50) *How to Master Home Video Games* (Bantam, \$2.95), a useless collection of common sense pieces by Mr. Hirschfeld; *The Video Game Scorebook* (Berkley, \$1.95); *Pac-Mania* (Beekman House, \$3.98), an excellent, full-color exploration of the phenomenon; and so on.

## FROM BORED TO BOARD

If videogame books leave you yearning for the more substantive games themselves, don't let that put you off reading altogether. There are a number of excellent new books which will captivate everyone who enjoys games.

Dover Publications (180 Varick Street, New York, NY, 10014) has long been producing some of the world's most interesting, if obscure books. Four recent titles are sure to puzzle or enlighten.

*Board and Table Games from Many Civilizations* (\$5.00) is an erudite and absorbing read. Author R.C. Bell details the history of board games, not only recounting their development (from the year 3000 B.C.) but serving up the rules for history's most popular and/or unusual such inventions. The book will prove particularly enlightening to videogame buffs, as it tends to lift one's sights: fun though they may be, there is clearly more to gaming than laser battles and avaricious munchers! In detailing civilization's greatest games, the book reveals the entertainment and intellectual potential which Odyssey 2's Master Strategy series and some of the multi-level arcade games are only just beginning to explore. Over three hundred illustrations of endlessly fascinating boards, cards, and game pieces make one yearn for the change to give these divertissements a try!

Dover offers us the chance to do just that with three other volumes whose appeal cuts across a broad spectrum of the videogaming audience. For *Pac-Man* and maze-game buffs, *The World's Most Difficult Maze* is just that: author Dave Phillips has whipped up a twenty-eight page maze, each leaf of which is accessible through holes in the previous page. This is a bargain at \$2.75.

Do you thrill to Atari's *Brain Games*? Are *Codebreaker* and *Nim* your idea of a good time? If so, Dover has D.G. Wells' *Recreations in Logic* (\$1.75) and C.R. Wylie's *111 Puzzles in Thought and Logic* (\$2.00), both of which will keep your gray matter pulsing for hours.

- When does  $7 - 9 = 8$ ?
- What's missing from this sign:  
C LOOPSEEND
- Decipher the message hidden herein:

EETIY  
SPLDPT  
PES EP  
LA T  
L IE

If you can exchange any of those used videogame books, these are the paperbacks on which to spend your credit!▲

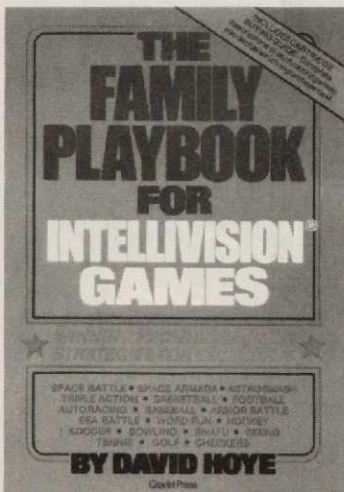



MR. & MRS.

# PAC-MAN

T.M.

PINBALL

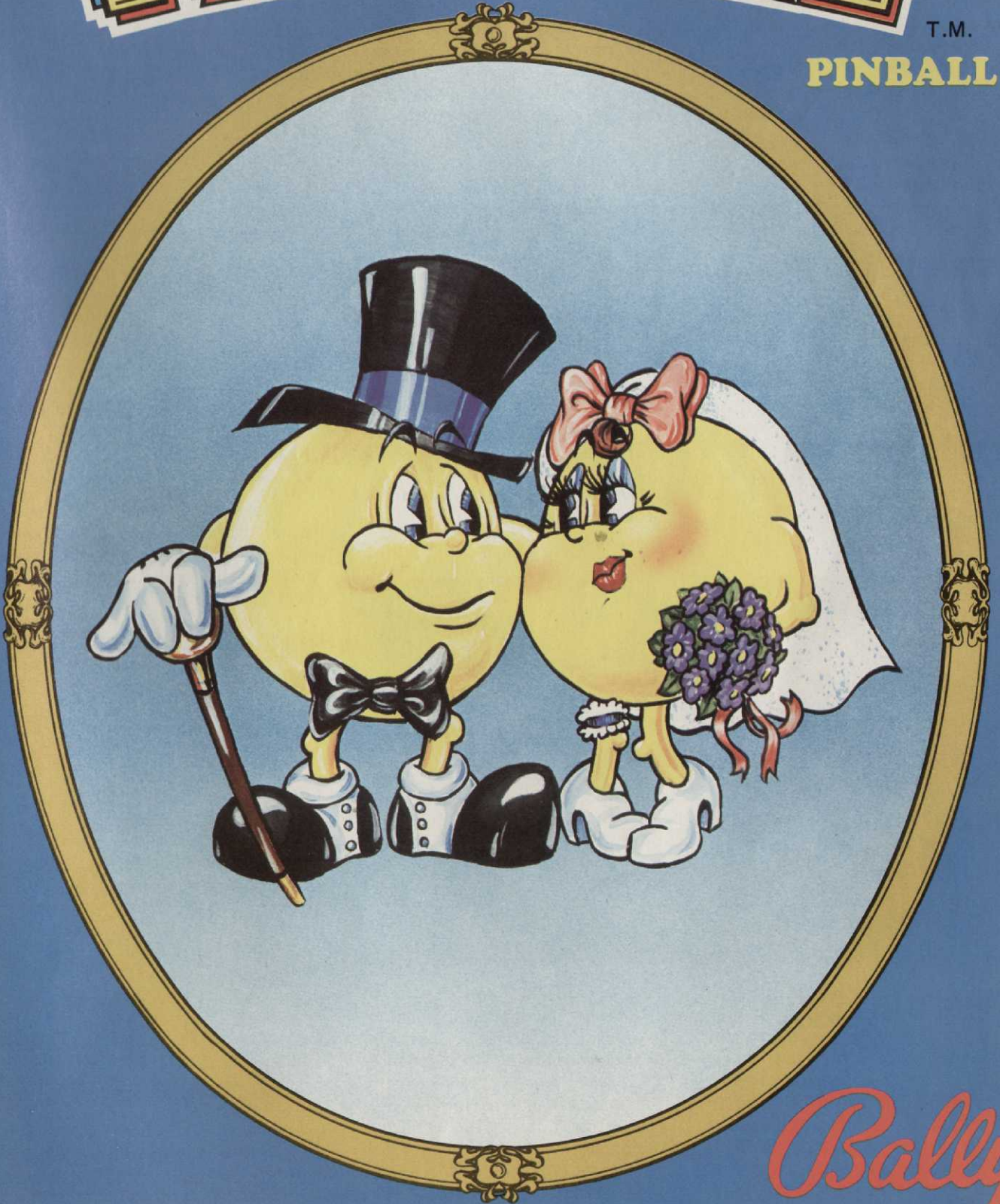

*Bally*<sup>®</sup>

The Newest Member Of The PAC-MAN Family



# YOU READ IT HERE FIRST!

Take a look at what your local videogame store is offering these days.

You're sure to notice a lot of space games, maze games to run you ragged, tank and card cartridges, airplane contests and races of many shapes and styles.

The editors of *Videogaming Illustrated* love these games, but in our own glib and arrogant way would like to suggest alternatives: new genres,

## *Sleepy Hollow*

A maze game with a particularly nasty twist.

You are lanky Ichabod Crane astride ignoble Gunpowder, riding the winding roads beneath the hills of Tarry Town. The player, from this lofty perch, must keep an eye on the numerous bridges which link the forest paths. For when the Headless Horseman leaps from the hedge — a different one each game — there are but moments to react. The ordinary heads are comparatively easy to dodge as they fly from near or far across the maze, but only a bridge will save you from the flaming jack-o'-lanterns. Secure on its planks, you must wait until the horseman leaves before heading home.



## *Big Bang*

All the matter which will comprise the universe sits in a seething orb at the center of your screen. Lights flicker and flash across the sphere, the very energy of creation. One player (or the computer) programs the correct sequence of ten colors which will signal the big bang; it's up to the other player to decipher that order before the energy dissipates and the screen goes blank.

## *Post Office*

Not the game you may have played at parties, but a frenzied battle to stop rising postal rates.

Your truck is filled with bags of mail, each one a different color. Above, mailboxes are perched along a winding road, their colors constantly changing. You must carry the mailbags one at a time to a mailbox which is the same color.

For every thirty seconds the game lasts, the cost of a first class stamp rises a penny. At every nickel interval, you are burdened with five new bags of mail.

Every once in a while a special delivery letter arrives, hefty revenue for the post office.

## *Roller Coaster*

The amusement park has been around for ages, and your job is to get up each morning and check out the Cyclone, the world's most decrepit roller coaster. Seated in the front car, you've got to count the ties as they whiz past during the tortuous, twining ride. Use your joystick to indicate which are all right, which are cracked down the center, and which are missing entirely.

new ideas. No r & d costs just ideas.

As before, we came up with thirty game descriptions and polled videogame players nationwide to determine their favorites. The result is the list presented below.

Each issue, *Videogaming Illustrated* will offer up new games. From current events to comic strips, no subject is off-limits — as indicated by the selection which follows.

## *Sand Castles*

A beach day's rained-out? Never fear! Just set up your sunlamp and enjoy building *Sand Castles*.

Your joystick controls a child and a pail. Scoop up a batch of sand and dump it on the beach. . . then another, and another. Erect a palace, if you wish, but remember: there are waves swelling just offshore, and you've no way of knowing when they'll come pounding ashore. Points are scored for every pailful you dump on the beach, the closer to the water and its unpredictable waves, the higher the value of each pail.

## *Swimming Hole*

There are two piers alongside the ole swimming hole, with inner tubes drifting about and rocks poking through the surface of the pond. You and an opponent launch yourselves from opposite shores, after selecting a position on the pier. Control your arc with the joystick: hitting a tube scores a point and returns you to the lakeside; missing forces you to swim slowly back; striking a rock leaves you momentarily dazed.

## *Morosco*

You've been handed the unpleasant assignment of destroying one of the oldest theatres on Broadway. You reason that the show must go on — progress, that is — and bring your wrecking ball to the front of the 19th century show-place.

But wait! You're having trouble swinging the ball because there are actors picketing in the streets. They move at different speeds; sometimes there are gaps in their ranks, sometimes there are none. Sometimes the irate performers actually scale the walls of the building, interfering with your work.

The lower your ball as it crashes into the theatre, the more points you score. Pounding the actors causes you to lose points. The game ends when the stately theatre is reduced to rubble. ▲





His father's gone.  
His mother's a memory.  
His brother's movin' on.

But Tex McCormick  
isn't giving in.



# TEX

Coming to theatres  
this summer.

TEX • Starring MATT DILLON • JIM METZLER • MEG TILLY • BILL McKINNEY and BEN JOHNSON  
Executive Producer Ron Miller • Produced by Tim Zinnemann  
Music by Pino Donaggio • Screenplay by Charlie Haas & Tim Hunter  
Based on the novel by S.E. Hinton • Directed by Tim Hunter • From Walt Disney Productions

©1982 Walt Disney Productions Released by Buena Vista Distribution Co., Inc. Technicolor®

**PG** PARENTAL GUIDANCE SUGGESTED  
SOME MATERIAL MAY NOT BE SUITABLE FOR CHILDREN



A Computerized Master Strategy Game by Odyssey<sup>2</sup>

# THE GREAT Wall Street Fortune Hunt

## ODYSSEY<sup>2</sup>

MCD 65 ABC 50 TWA 53

PRIME RATE UP 1 POINT

3. SRS 1000 AT 65



## ODYSSEY<sup>2</sup>

Join the fast moving and highly unpredictable  
investment world.

**BUY! SELL! TRADE! MAKE MONEY!**